

# ARBOR COMPACT SERIES

COMMERCIAL UNITS



**GEOSTAR**  
AFFORDABLE RENEWABLE CLEAN



# Table of Contents

Model Nomenclature ..... 4

AHRI Data ..... 5-6

The Arbor Compact Series ..... 7-11

Inside the Arbor Compact Series ..... 13-15

Controls ..... 16-19

Application Notes ..... 20-22

Water Quality ..... 22

Installation Notes ..... 23-25

Vertical Dimensional Data ..... 26-27

Horizontal Dimensional Data ..... 28-29

Hanger Bracket Locations ..... 30

Physical Data ..... 31

Electrical Availability ..... 32

Electrical Data ..... 33-35

Blower Performance Data ..... 36-39

Selection Example ..... 40-41

Reference Calculations ..... 42

Legend and Notes ..... 42

Operating Limits ..... 43

Correction Factor Tables ..... 43

Pressure Drop ..... 44

Performance Data ..... 45-67

Wiring Schematics ..... 68-73

Engineering Guide Specifications ..... 74-76

Revision Guide ..... 77

# Model Nomenclature

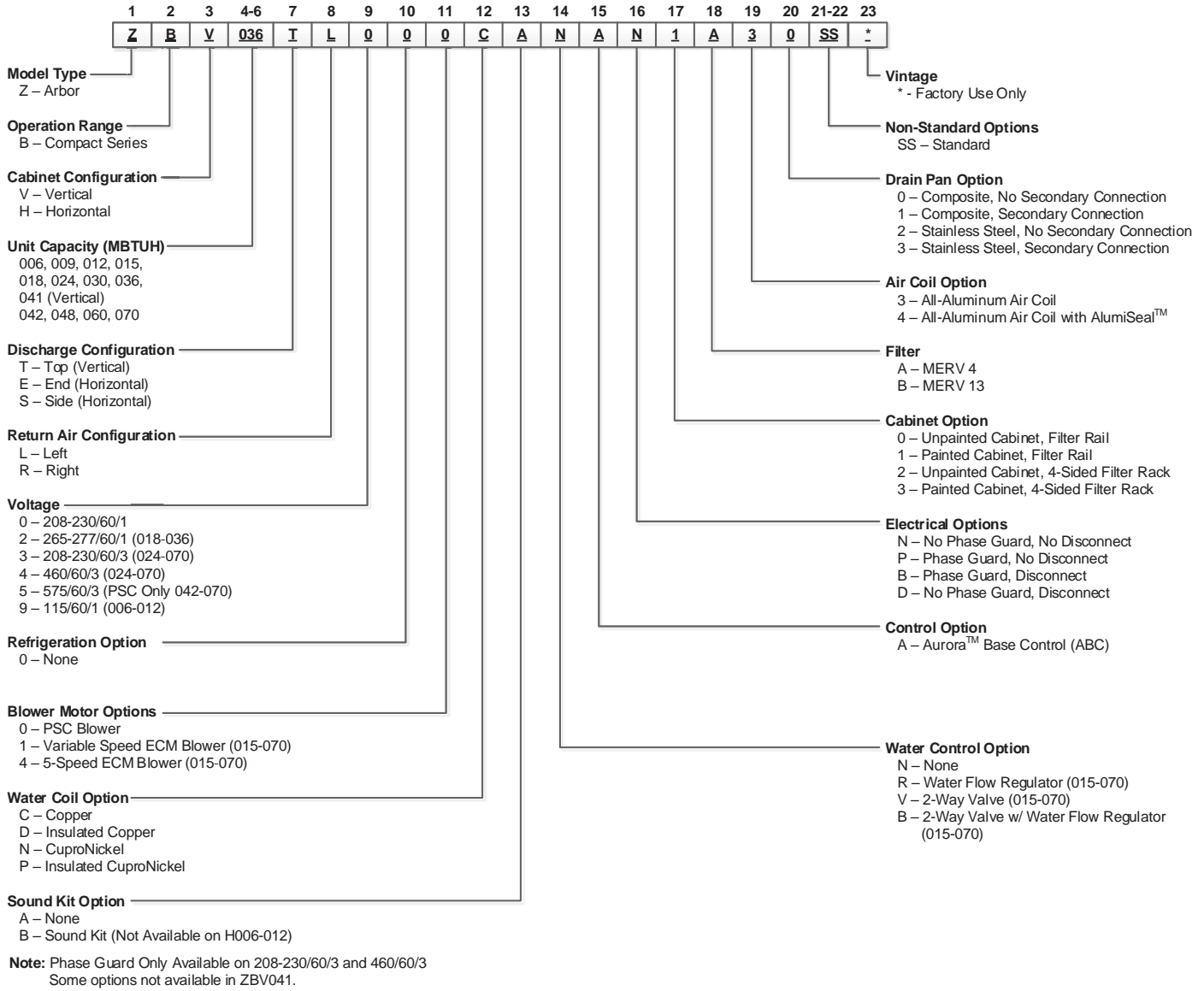

# AHRI Data

## PSC Motors

AHRI/ASHRAE/ISO 13256-1

English (IP) Units

Model	Flow Rate		Water Loop Heat Pump				Ground Water Heat Pump				Ground Loop Heat Pump			
			Cooling EWT 86°F		Heating EWT 68°F		Cooling EWT 59°F		Heating EWT 50°F		Cooling EWT 77°F		Heating EWT 32°F	
	gpm	cfm	Capacity Btuh	EER Btuh/W	Capacity Btuh	COP	Capacity Btuh	EER Btuh/W	Capacity Btuh	COP	Capacity Btuh	EER Btuh/W	Capacity Btuh	COP
006	2.0	250	7,100	13.4	8,000	4.3	8,400	21.3	6,800	3.8	7,400	15.5	5,400	3.2
009	3.0	350	8,100	12.2	11,400	4.6	9,900	19.2	9,600	4.0	8,900	14.5	7,600	3.4
012	3.0	400	10,200	12.2	15,200	4.4	12,200	18.2	12,600	3.9	11,200	14.2	10,200	3.5
015	4.0	500	13,200	12.5	15,400	4.5	16,000	20.0	13,000	4.0	14,000	15.3	10,400	3.2
018	5.0	600	17,300	13.4	19,000	4.3	19,800	20.5	16,000	3.7	18,000	15.4	12,600	3.2
024	6.0	800	22,900	13.0	26,000	4.5	27,000	19.8	22,600	4.0	24,500	14.8	17,000	3.3
030	8.0	1000	28,400	13.8	34,000	4.5	33,500	21.0	28,000	4.0	30,000	16.0	21,000	3.3
036	9.0	1150	34,500	14.0	43,800	4.7	40,000	22.0	35,600	4.2	36,000	16.3	26,000	3.3
041	11.0	1100	37,600	13.5	48,000	4.3	44,500	20.4	38,500	3.8	40,000	15.0	28,500	3.2
042	11.0	1400	39,200	13.2	51,000	4.7	47,000	20.4	41,400	4.3	42,000	15.2	30,500	3.3
048	12.0	1600	47,200	13.0	59,000	4.6	57,000	19.8	48,000	4.0	49,500	15.0	36,500	3.3
060	15.0	1900	57,000	13.5	66,000	4.3	67,000	21.0	55,000	4.0	58,000	15.2	43,000	3.3
070	18.0	2100	66,000	14.0	80,000	4.5	75,000	20.5	64,000	4.0	68,000	15.6	49,000	3.3

8/9/18

Cooling capacities based upon 80.6°F DB, 66.2°F WB entering air temperature

Heating capacities based upon 68°F DB, 59°F WB entering air temperature

All ratings based upon 208V operation

## Variable Speed ECM, 5 Speed ECM motor

AHRI/ASHRAE/ISO 13256-1

English (IP) Units

Model	Flow Rate		Water Loop Heat Pump				Ground Water Heat Pump				Ground Loop Heat Pump			
			Cooling EWT 86°F		Heating EWT 68°F		Cooling EWT 59°F		Heating EWT 50°F		Cooling EWT 77°F		Heating EWT 32°F	
	gpm	cfm	Capacity Btuh	EER Btuh/W	Capacity Btuh	COP	Capacity Btuh	EER Btuh/W	Capacity Btuh	COP	Capacity Btuh	EER Btuh/W	Capacity Btuh	COP
006	2.0	250	7,150	14.0	8,500	4.4	8,600	22.0	7,100	4.0	7,600	16.0	5,500	3.2
009	3.0	350	8,300	13.4	11,500	4.8	10,300	22.0	9,600	4.1	9,100	15.0	7,600	3.4
012	3.0	400	10,300	13.0	14,500	4.5	12,800	20.0	11,900	4.0	11,300	15.0	10,200	3.5
015	4.0	500	13,800	13.2	16,100	4.6	16,000	21.0	13,400	4.1	14,200	15.7	11,000	3.3
018	5.0	600	17,300	14.2	19,000	4.5	19,800	22.0	16,000	3.9	18,000	16.2	12,600	3.3
024	6.0	800	22,900	13.6	26,000	4.7	27,000	20.8	22,600	4.2	24,500	15.6	17,000	3.5
030	8.0	900	28,400	14.7	34,000	4.7	33,500	22.5	28,000	4.2	30,000	17.0	21,000	3.5
036	9.0	1150	34,500	14.5	43,800	4.9	40,000	23.0	35,600	4.4	36,000	17.0	26,000	3.5
041	11.0	1300	39,000	13.9	48,500	4.7	45,000	21.0	38,500	4.1	41,000	16.0	28,500	3.4
042	11.0	1400	39,200	14.2	51,000	4.9	47,000	22.0	41,400	4.5	42,000	16.6	30,500	3.5
048	12.0	1600	47,200	14.0	59,000	4.8	57,000	21.0	48,000	4.2	49,500	16.0	36,500	3.5
060	15.0	1900	57,000	14.0	66,000	4.6	67,000	22.0	55,000	4.2	58,000	16.0	43,000	3.5
070	18.0	2100	66,000	14.6	80,000	4.7	75,000	22.0	64,000	4.2	68,000	16.6	49,000	3.5

8/9/18

Cooling capacities based upon 80.6°F DB, 66.2°F WB entering air temperature

Heating capacities based upon 68°F DB, 59°F WB entering air temperature

All ratings based upon 208V operation



All Arbor Compact Series product is safety listed under UL1995 thru ETL and performance listed with AHRI in accordance with standard 13256-1.

## AHRI Data cont.

The performance standard AHRI/ASHRAE/ISO 13256-1 became effective January 1, 2000 and replaces AHRI Standards 320, 325, and 330. This new standard has three major categories: Water Loop (comparable to ARI 320), Ground Water (ARI 325), and Ground Loop (ARI 330). Although these standards are similar there are some differences:

### Unit of Measure: The Cooling COP

The cooling efficiency is measured in EER (US version measured in Btu/h per Watt. The Metric version is measured in a cooling COP (Watt per Watt) similar to the traditional COP measurement.

### Water Conditions Differences

Entering water temperatures have changed to reflect the centigrade temperature scale. For instance the water loop heating test is performed with 68°F (20°C) water rounded down from the old 70°F (21.1°C).

### Air Conditions Differences

Entering air temperatures have also changed (rounded down) to reflect the centigrade temperature scale. For instance the cooling tests are performed with 80.6°F (27°C) dry bulb and 66.2°F (19°C) wet bulb entering air instead of the traditional 80°F (26.7°C) DB and 67°F (19.4°C) WB entering air temperatures. 80.6/66.2 data may be converted to 80/67 using the entering air correction table. This represents a significantly lower relative humidity than the old 80/67 of 50% and will result in lower latent capacities.

### Pump Power Correction Calculation

Within each model, only one water flow rate is specified for all three groups and pumping Watts are calculated using the following formula. This additional power is added onto the existing power consumption.

- Pump power correction = (gpm x 0.0631) x (Press Drop x 2990) / 300

Where 'gpm' is waterflow in gpm and 'Press Drop' is the pressure drop through the unit heat exchanger at rated water flow in feet of head.

### Blower Power Correction Calculation

Blower power is corrected to zero external static pressure using the following equation. The nominal airflow is rated at a specific external static pressure. This effectively reduces the power consumption of the unit and increases cooling capacity but decreases heating capacity. These Watts are significant enough in most cases to increase EER and COPs fairly dramatically over ARI 320, 325, and 330 ratings.

- Blower Power Correction = (cfm x 0.472) x (esp x 249) / 300

Where 'cfm' is airflow in cfm and 'esp' is the external static pressure at rated airflow in inches of water gauge.

### ISO Capacity and Efficiency Calculations

The following equations illustrate cooling calculations:

- ISO Cooling Capacity = Cooling Capacity (Btu/h) + (Blower Power Correction (Watts) x 3.412)
- ISO EER Efficiency (W/W) = ISO Cooling Capacity (Btu/h) x 3.412 / [Power Input (Watts) - Blower Power Correction (Watts) + Pump Power Correction (Watt)]

The following equations illustrate heating calculations:

- ISO Heating Capacity = Heating Capacity (Btu/h) - (Blower Power Correction (Watts) x 3.412)
- ISO COP Efficiency (W/W) = ISO Heating Capacity (Btu/h) x 3.412 / [Power Input (Watts) - Blower Power Correction (Watts) + Pump Power Correction (Watt)]

### Comparison of Test Conditions

	ARI 320	ISO/AHRI 13256-1 WLHP	ARI 325	ISO/AHRI 13256-1 GWHP	ARI 330	ISO/AHRI 13256-1 GLHP
<b>Cooling</b>						
Entering Air - DB/WB °F	80/67	80.6/66.2	80/67	80.6/66.2	80/67	80.6/66.2
Entering Water - °F	85	86	50/70	59	77	77
Fluid Flow Rate	*	**	**	**	**	**
<b>Heating</b>						
Entering Air - DB/WB °F	70	68	70	68	70	68
Entering Water - °F	70	68	50/70	50	32	32
Fluid Flow Rate	*	**	**	**	**	**

Note \*: Flow rate is set by 10°F rise in standard cooling test Part load entering water conditions not shown.

Note \*\*: Flow rate is specified by the manufacturer

WLHP = Water Loop Heat Pump; GWHP = Ground Water Heat Pump; GLHP = Ground Loop Heat Pump

### Conversions:

Airflow (lps) = cfm x 0.472;

esp (Pascals) = esp (in wg) x 249;

Water Flow (lps) = gpm x 0.0631;

Press Drop (Pascals) = Press Drop (ft hd) x 2990

# The Arbor Compact Series

The Arbor Compact is the latest in GeoStar’s efforts to be the best in the water source heat pump industry. The Arbor Compact raises the bar for boiler/tower applications by providing flexibility and efficiency into a compact cabinet at a competitive price. A compact cabinet is important when choosing a replacement heat pump. Many water source heat pumps of the 1980-90’s were relatively low efficiency models with a small footprint. Once they are installed in a building and piping and ductwork is piped around the unit replacement with a larger footprint is nearly impossible. The Arbor Compact combines the high efficiency of 21<sup>st</sup> century product in a footprint that matches a 1980 heat pump for easy replacement. The chart below shows a comparison of a typical 1980 legacy wshp and current competitor data versus the Arbor Compact Series.

This full range product offers all the standard commercial voltages using high efficiency rotary and scroll compressors along with either 3-speed permanent split-capacitor (PSC), 5-speed ECM, or variable speed ECM blower motors.

Year	WaterSource Heat Pump	WLHP EER (PSC/ECM)	Height [in.]	Width [in.]	Length [in.]
<b>3 Ton Horizontal WSHP</b>					
1980	Typical Legacy Unit	11.6/-	21.0	20.2	41.2
2018	Competitor A Compact Unit	14.2/-	19.0	22.0	54.5
2018	Competitor B Compact Unit	13.5/14	21.0	20.1	47.1
2018	Competitor C Compact Unit	13.7/-	19.0	25.0	50.0
2018	Arbor Compact	14/14.5	19.2	22.5	42.0
<b>4 Ton Horizontal WSHP</b>					
1980	Typical Legacy Unit	10.4/-	21.0	27.2	46.2
2018	Competitor A Compact Unit	13/-	21.0	25.0	54.5
2018	Competitor B Compact Unit	13.3/14.2	21.0	24.1	54.1
2018	Competitor C Compact Unit	13.13/-	21.0	33.0	58.0
2018	Arbor Compact	13/14	19.2	22.5	45.0

### Arbor Compact Highlights

- High efficiency performance
  - With PSC Blower Motor Up to 14.0 EER and 4.7 COP (ISO/AHRI 13256-1-WLHP)
  - With Variable Speed ECM Blower Motor Up to 14.7 EER and 4.9 COP (ISO/AHRI 13256-1-WLHP)
  - With 5-Speed ECM Blower Motor Up to 14.7 EER and 4.9 COP (ISO/AHRI 13256-1-WLHP)
- Unrivaled cabinet footprint that can fit most application requirements
  - A four ton horizontal unit less than four feet long means the smallest horizontal cabinets in the industry!
- All-Aluminum rifled tube-and-fin air coils are not susceptible to formicary corrosion.
- Dedicated 460V 5-Speed ECM does not require use of a neutral!
- Aurora Base microprocessor control capable of operating 5-speed ECM or variable speed ECM with internally mounted 2-way valve
- Flexible factory installed options
  - Corrosion-proof composite or stainless steel drain pan; including internally mounted secondary drain connection option
  - Copper or cupronickel heat exchanger and optional low temperature insulation
  - Filter options: standard 1 in. MERV 4 or option 2 in. MERV 13 with either filter rails or option deluxe four sided filter rack that is field switchable between 1 in. and 2 in.
  - Aurora Base Control
  - Factory mounted internal water valve and/or flow regulator for variable speed pumping systems saves on installation costs
- Other options: Sound Kit, Coated Air Coil, Phase Guard, Internally Mounted Non-fused Power Disconnect



### Vertical Arbor Compact Series

Models ZBV 006-070 (0.5-6 tons) Single Speed

### Horizontal Arbor Compact Series

Models ZBH 006-070 (0.5-6 tons) Single Speed

## The Arbor Compact Series cont.

### Product Features: Vertical Cabinet

Arbor Compact vertical units are designed for high efficiency, maximum flexibility, and primary servicing from the front.

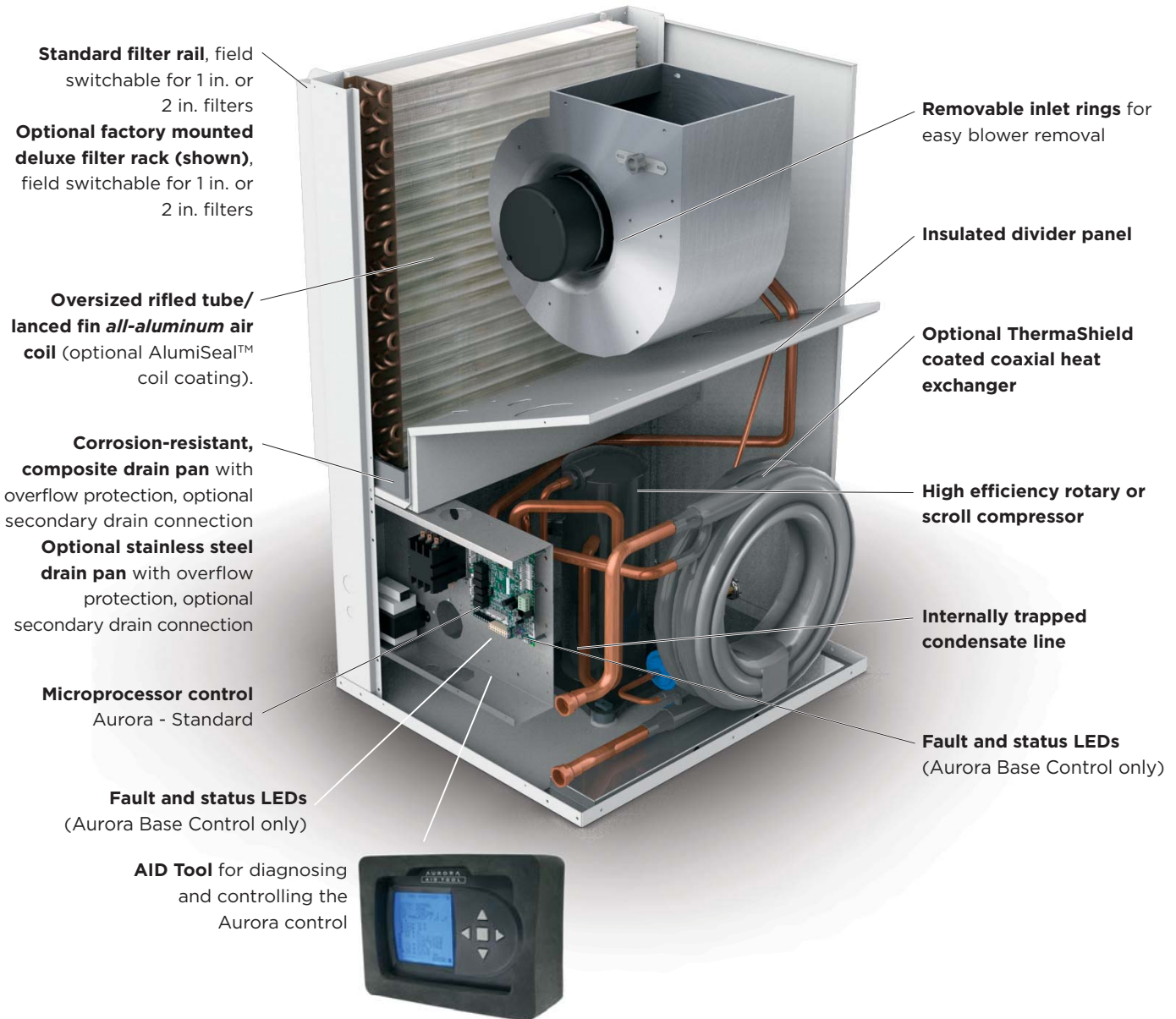

A true left and right return option is available.



## The Arbor Compact Series cont.

### Product Features: Horizontal Cabinet

Horizontal units are designed for high efficiency, maximum flexibility, and primary servicing from the front.

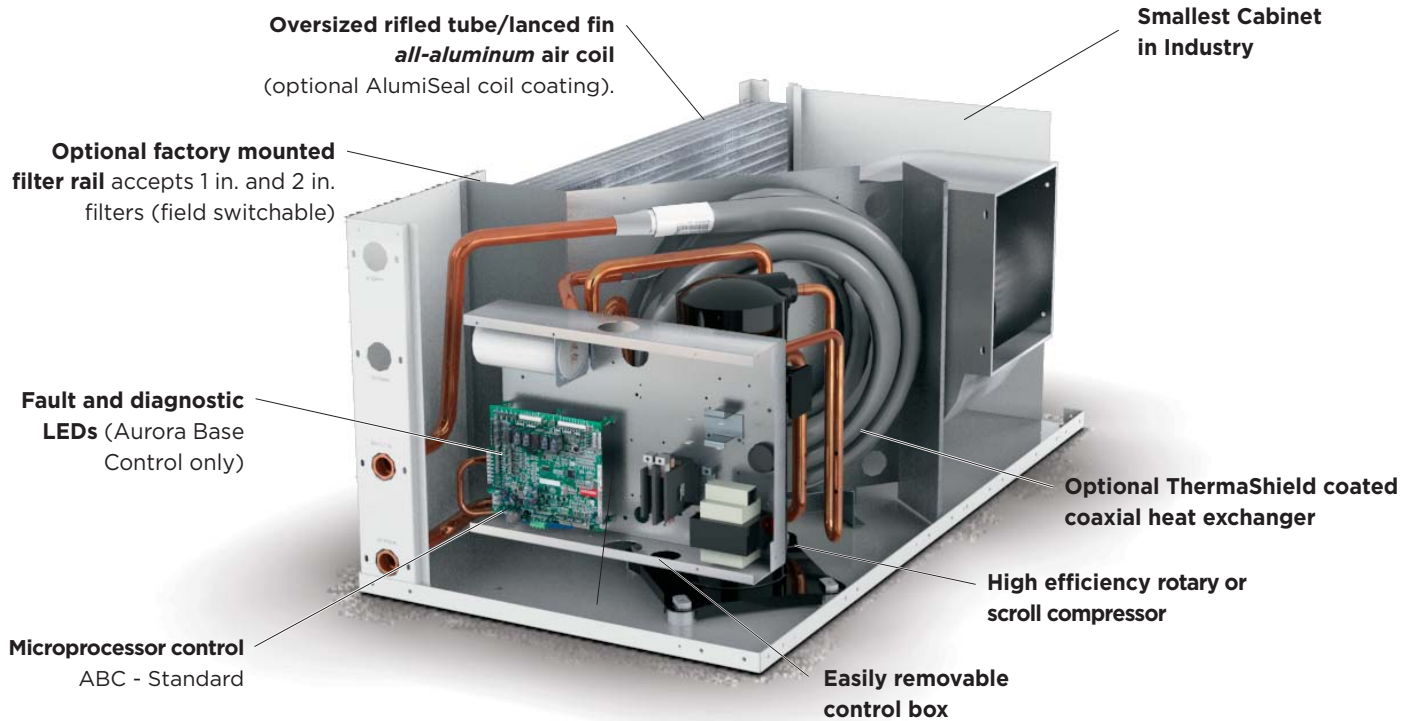

Four blower deck options are available. Factory or field conversion option of end or side discharge using switchable access panels and a factory only option of true left or right return air coil.

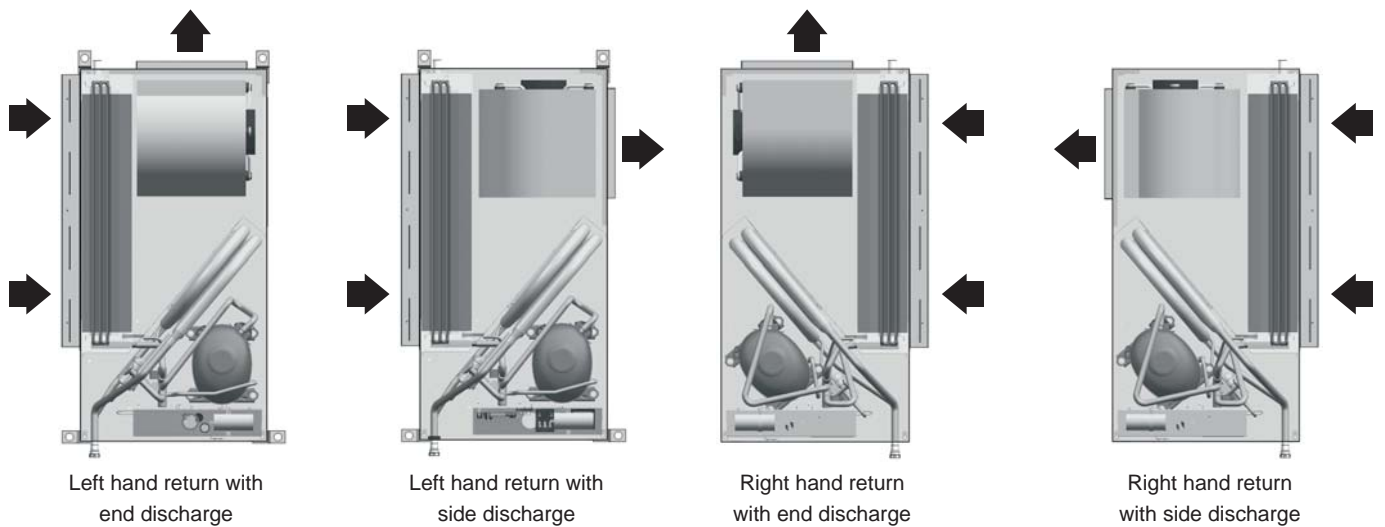

## The Arbor Compact Series cont.

### Flexible Product with Several Standard Options

- Compact cabinet design, vertical and horizontal with true left and right return configurations
- Horizontal end and side discharge with vertical top discharge air configurations
- Capacities of 6,000 through 70,000 Btu/h
- All commercial voltages including 115/60/1, 208-230/60/1, 265-277/60/1, 208-230/60/3, 460/60/3, and 575/60/3.
- 3 speed PSC, 5 speed ECM, or optional variable speed ECM blower motors
- All-Aluminum rifled tube-and-fin air coils are not susceptible to formicary corrosion.
- Optional AlumiSeal air coil e-coating for improved condensate runoff
- Extended range insulation option
- Super Quiet Sound Package, including multi-density compressor blanket
- Quiet rotary/scroll compressors in all models
- 2-dimension refrigerant piping vibration loops to isolate the compressor
- Discharge mufflers on sizes 048-070
- Heavy gauge cabinet and 4 vibration isolating hanger brackets
- Internally mounted water flow regulator and/or water solenoid valve for variable speed pumping systems
- Standard Aurora Base Control
- Phase guard with optional 'dial' disconnect
- Polymer composite drain pan or stainless steel drain pan with optional secondary drain connection
- 1 in. MERV 4 or 2 in. MERV 13 filters

Other options are available by special request through GeoStar Commercial Sales.

### High Efficiency

The Arbor Compact Series is a high efficiency water source heat pump in a compact vertical and horizontal cabinet. The product features highly efficient and reliable single capacity rotary/scroll compressors mated with large blowers. These blowers are driven by efficient 3 speed PSC blower motors, 5-speed ECM blower motors, or highly efficient variable speed ECM blower motors.

### Super Quiet Option

An optional Super Quiet Sound Package is also available for a modest cost and features multi-density laminate lined compressor blanket designed to completely surround the compressor and suppress low frequency noise.

### Indoor Air Quality (IAQ)

All Arbor Compact Series features several IAQ benefits:

- Corrosion-free composite double-sloped drain pan to eliminate standing water and prevent bacterial growth

- A washable surface on insulation in all air handler compartments to allow cleanability and inhibit bacteria growth. Optional non-fibrous closed cell insulation is also available for more sensitive applications by special request through commercial sales..
- Open filter rail comes standard for non-ducted return applications. Filter rail is field switchable from 1 in. to 2 in. [2.54 to 5.1 cm] for more filter options.
- Optional factory mounted, four sided, deluxe filter rack that is field switchable from 1 in. to 2 in. [2.54 to 5.1 cm] is available for ducted return applications.
- Standard supplied filter is a pleated MERV 4, 1 in. [2.54 cm]. An optional low static high efficiency 2 in. [5.1 cm] MERV 13, for LEED certification points, is also available.



### Internally Mounted Solenoid Valve Option

When variable speed circulating pump systems are designed, low pressure drop (high Cv) solenoid valves are specified at each unit to vary the pump according to flow required. It is important that these valves be low pressure drop to avoid unwanted pump watts. This option factory installs this valve inside the unit.

### Secondary Drain Connection Option

Some local building authority's interpretation of codes require more condensate overflow protection than standard microprocessor based condensate sensors offer. In these areas a full secondary drain pan might be required causing both increased cost and unit service access issues. In many of these cases a secondary drain connection option can be added to the unit to pass this local interpretation of condensate drain redundancy. This option adds a second PVC drain connection to the drain pan at a higher level.



### Phase Guard Monitor

Factory mounted phase guard device is available to protect the compressor against loss of phase.

## The Arbor Compact Series cont.

### Aurora Base Control

The Aurora Base Control (ABC) System is a complete residential and commercial comfort system that brings all aspects of the HVAC system into one cohesive module network. Aurora uses the Modbus communication protocol to communicate between modules. Each module contains the logic to control all features that are connected to the module. The Aurora Base Control (ABC) has two Modbus channels. The first channel is configured as a master for connecting to devices such as a communicating thermostat, expansion board, or other slave devices. The second channel is configured as a slave for connecting the Aurora Interface Diagnostic (AID) Tool.

Control	General Description	Application	Display/Interface	Protocol
<p data-bbox="175 743 358 764"><b>Aurora Base Control</b></p> 	<p data-bbox="402 743 823 968">The ABC microprocessor provides all the features necessary to operate today's standard WSHPs that utilize dual capacity compressors and variable speed ECM/5-speed ECM blower motors with hot gas reheat. This control can communicate to a handheld diagnostic tool to help the installing contractor or service technician with equipment setup and service. By utilizing Modbus RTU communication protocol, the ABC board can communicate with additional devices on the Aurora network.</p>	<p data-bbox="846 743 1180 989">Used for residential and commercial applications that use single or dual capacity compressors with PSC, 5-speed ECM, or variable speed ECM blower motors. This base control can also communicate to the AID Tool to display faults, inputs/outputs, and software revision. Commercial features such as hot gas reheat, slow opening water valve, and random start are also capable with the ABC board.</p>	<p data-bbox="1203 743 1375 810">Optional AID Tool can be used for field service.</p>	<p data-bbox="1409 743 1507 764">Standalone</p>

## The Arbor Compact Series cont.

---

### Electrical Disconnect

An optional factory mounted, internally (ZBV/H006-012 externally mounted) wired disconnect is available to avoid scheduling problems with the electrical contractor.

Other features include:

- Non-fused, 'dial' type switch with "on/off" position
- Compact design
- "Lockout/Tagout" feature to keep the unit "off" during service



### Low Ceiling Height Requirement (Horizontal 006-012)

Utilizing a raised drain pan, the condensate drain trap on horizontal models 006 through 012 can be made within the height of the cabinet. This allows the Arbor Compact to be installed without any additional ceiling height, or in areas where ceiling height is at a premium. The Arbor Compact 006-012 models have the lowest ceiling height installation requirements of any AHRI listed

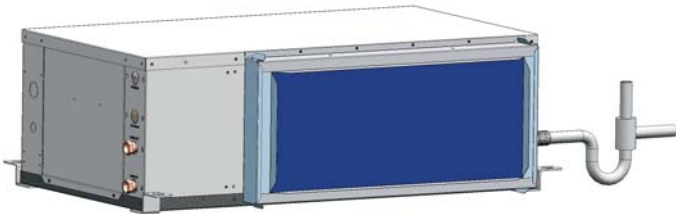

manufacturer.

### Factory Quality

- All refrigerant brazing is performed in a nitrogen environment.
- Computer controlled deep vacuum and refrigerant charging system.
- All joints are leak detected for maximum leak rate of less than 1/4 oz. per year.
- Computer bar code equipped assembly line ensures all components are correct.
- All units are computer run-tested with water to verify both function and performance.

## Inside the Arbor Compact Series

### Refrigerant

Arbor Compact products all feature zero ozone depletion and low global warming potential refrigerant R-410A.

### Cabinet

All units are constructed of corrosion resistant galvanized sheet metal. One large lift-out access panel provides access to the compressor and air handler section to allow servicing of blower motor, blower, and drain pan. Refrigerant circuit is designed to allow primary serviceability from the front. Six (6) horizontal and six (6) vertical cabinets are provided for application flexibility. The blower motor and blower can be completely serviced or replaced without removal of the unit. Service of the blower and blower motor is made easier via the removable orifice ring on the housing.

Flexible configurations include four (4) blower deck options for horizontals and a true left and right return on both horizontal and vertical and the smallest horizontal cabinet in the industry.

### Filter Rack

All units come standard with an open filter rail, for use in open return applications, or an optional deluxe filter rack/duct collar for use with ducted returns. Both filter options are field switchable between 1 in. [2.54 cm] and 2 in. [5.1 cm] thick filters for filter flexibility. A MERV 4, 1 in. [2.54 cm] is standard with an optional 2 in. [5.1 cm] MERV 13 for LEED certification points and high efficiency filtration.



### Electrical Box

Unit controls feature quick connect wiring harnesses for easy servicing. Separate knockouts for low voltage and two sides of the electrical corner post for easy access to the control box. 50VA or large 75VA transformer assures adequate controls power for accessories.

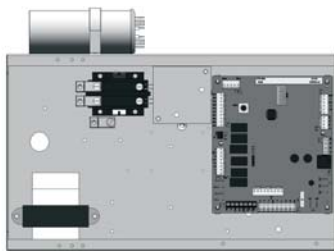

### Horizontal Hanger Kits

Each horizontal unit includes a hanger kit to meet seismic specification requirements while still allowing filter access.



### Drain Pan

All condensate connections are PVC glue for economical corrosion free connections. Bacteria resistant composite drain pan is sloped to promote complete drainage and will never rust or corrode. Complete drainage helps to inhibit bacterial or microbial growth. Vertical units feature an internally trapped condensate line using clear PVC hose for easy inspection and reduced installation cost. Optional factory installed stainless steel drain pans are also available.



### Compressors

The Arbor Compact features high efficiency R-410A rotary (006 - 018) and scroll (024 - 070) compressors. These types of compressors provide both high efficiency and great reliability.



## Inside the Arbor Compact Series cont.

### Air Handler Insulation

Washable air handler insulation surface provides cleanability to further enhance IAQ.

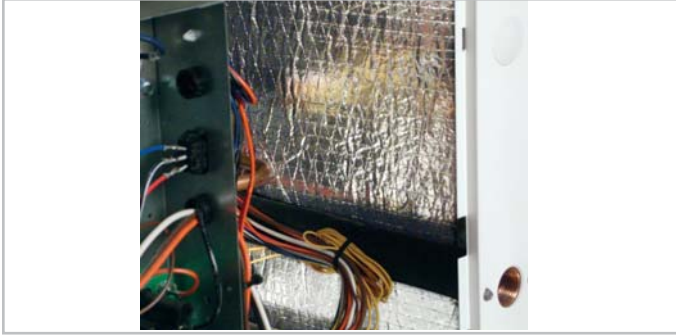

### Service Connections and Serviceability

Two Schrader service ports are provided in every unit. The suction side and discharge side ports are for field charging and servicing access. All valves are 7/16 in. SAE connections. All water and electrical connections are made from the front of the unit. Unit is designed for front access serviceability.



### 4-Way Reversing Valve

Arbor Compact units feature a reliable all-brass pilot operated refrigerant reversing valve. The reversing valve operation is limited to change of mode by the control to enhance reliability.



### Thermostatic Expansion Valve

All Arbor Compact models utilize a balanced port bidirectional thermostatic expansion valve (TXV) for refrigerant metering. This allows precise refrigerant flow in a wide range of entering water variation (20 to 120°F [-7 to 49°C]) found in geothermal systems. The TXV is located in the compressor compartment for easy access.



### All-Aluminum Air Coil

All models in the Arbor Compact line ship with all-aluminum air coils. GeoStar is the first manufacturer to offer an all-aluminum round-tube-and-fin air coil in a packaged water source heat pump. These air coils are constructed of lanced fin and rifled tube aluminum that is not susceptible to formicary corrosion. For additional condensate runoff and meeting project specifications, an optional AlumiSeal e-coating is available.



### Water-to-Refrigerant Coaxial Heat Exchanger Coil

Coaxial refrigerant to water heat exchangers provide unparalleled efficiency. The coaxes are designed for low pressure drop and low flow rates. All coaxes are pressure rated to 450 psi water side and 600 psi on the refrigerant side. Optional ThermaShield coating is available on the water-to-refrigerant heat exchanger to prevent condensation in low temperature loop operation.



## Inside the Arbor Compact Series cont.

### Blower Motor and Housing

High efficiency low rpm galvanized direct drive blower featuring 3 speed permanently split capacitor (PSC) motor, 5-speed ECM motor, and optional variable speed ECM blower motor. The variable speed ECM motor is controlled directly through the unit's microprocessor control. The lower rpm blower also reduces air noise. All PSC and 5-speed ECM motors have speed selection terminal strip on the motor for easy speed change. All motors are vibration isolated to reduce noise. Horizontal units can be field converted from end to side discharge as well.

**NOTE:** 460V 5-speed ECM blower motor does not require a neutral wire.

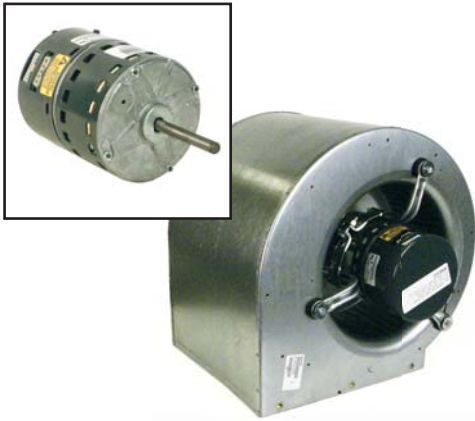

### 5-Speed ECM Constant Torque Motors

The 5-speed ECM is a 'Constant Torque' ECM motor and delivers air flow similar to a PSC but operates as efficiently as an variable speed ECM Motor. Because it's an ECM Motor, the 5-speed ECM can ramp slowly up or down like the variable speed ECM Motor. There are 5 possible speed taps available on the 5-speed motor with #1 being the lowest airflow and #5 being the highest airflow. These speed selections are preset at the time of manufacture and are easily changed in the field if necessary.

#### 5-Speed ECM Benefits:

- High efficiency
- Soft start
- 5 speeds with up to 4 speeds on-line
- Built in logic allows air flow to change with G, Y1, Y2 and W signals
- Super efficient low airflow continuous blower setting (G)

## Controls - Aurora Base Control

### Aurora 'Base' Control

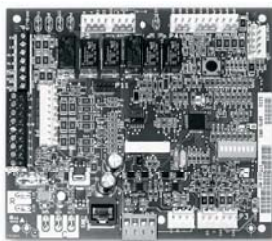

**NOTE:** Refer to the Aurora Base Control Application and Troubleshooting Guide and the Instruction Guide: Aurora Interface and Diagnostics (AID) Tool for additional information.

### Control Features

Software ABC Standard Version 2.0

#### Single or Dual Capacity Compressors

Either single or dual capacity compressors can be operated.

#### ECM Blower Motor Option

An ECM blower motor can be driven directly using the onboard PWM output. Four blower speeds are available based upon the G, Y1, Y2, and W input signals to the board. The blower speeds can be changed either by the ECM manual configurations mode method or by using the Aurora AID Tool directly. All four blower speeds can be set to the same speed if desired.

#### 5-Speed ECM Blower Motor Option

A 5-Speed ECM blower motor will be driven directly using the thermostat connections. Any of the G, Y1, or Y2/W signals can drive any of the 5 available pre-programmed blower speeds on the motor.

### Other Control Features

- Random start at power up
- Anti-short cycle protection
- High and low pressure cutouts
- Loss of charge
- Water coil freeze detection
- Air coil freeze detection
- Over/under voltage protection
- Condensate overflow sensor
- Load shed
- Dehumidification (where applicable)
- Emergency shutdown
- Hot gas reheat operation (where applicable)
- Diagnostic LED
- Test mode push button switch
- Two auxiliary electric heat outputs
- Alarm output
- Accessory output with N.O. and N.C.
- Modbus communication (master)
- Modbus communication (slave)

### Field Selectable Options via Hardware

**DIP Switch (SW1)** – Test/Configuration Button (See SW1 Operation Table)

#### Test Mode

The control is placed in the test mode by holding the push button switch SW1 for 2 - 5 seconds. In test mode most of the control timings will be shortened by a factor of sixteen (16). LED3 (green) will flash at 1 second on and 1 second off. Additionally, when entering test mode LED1 (red) will flash the last lockout one time. Test mode will automatically time out after 30 minutes. Test mode can be exited by pressing and holding the SW1 button for 2 to 5 seconds or by cycling the power. **NOTE:** Test mode will automatically be exited after 30 minutes.

#### ECM Configuration Mode

The control is placed in the ECM configuration mode by holding the pushbutton switch SW1 for 5 to 10 seconds, the high, low, and "G" ECM speeds can be selected by following the LED display lights. LED2 (yellow) will fast flash when entering the ECM configuration. When setting "G" speed LED3 (green) will be continuously lit, for low speed LED1 (red) will be continuously lit, and for high speed both LED3 (green) and LED1 (red) will be continuously lit. During the ECM configuration mode LED2 (yellow) will flash each of the 12 possible blower speeds 3 times. When the desired speed is flashed press SW1, LED2 will fast flash until SW1 is released. "G" speed has now been selected. Next select low speed, and high speed blower selections following the same process above. After third selection has been made, the control will exit the ECM configuration mode. Aux fan speed will remain at default or current setting and requires the AID Tool for adjustment.

#### Reset Configuration Mode

The control is placed in reset configuration mode by holding the push button switch SW1 for 50 to 60 seconds. This will reset all configuration settings and the EEPROM back to the factory default settings. LED3 (green) will turn off when entering reset configuration mode. Once LED3 (green) turns off, release SW1 and the control will reset.

#### DIP Switch (SW2)

**SW2-1** FP1 Selection – Low water coil temperature limit setting for freeze detection. On = 30°F; Off = 15°F.

**SW2-2** FP2 Selection – On = 30°F; Off = N/A

**SW2-3** RV – O/B - thermostat type. Heat pump thermostats with "O" output in cooling or "B" output in Heating can be selected. On = O; Off = B.

**SW2-4** Access Relay Operation (P2) and 2-5

Access Relay Operation	SW2-4	SW2-5
Cycle with Blower	ON	ON
Cycle with Compressor	OFF	OFF
Water Valve Slow Opening	ON	OFF
Cycle with Comm. T-stat Hum Cmd	OFF	ON



## Controls - Aurora Base Control cont.

**Cycle with Blower** - The accessory relay will cycle with the blower output.

**Cycle with Compressor** - The accessory relay will cycle with the compressor output.

**Water Valve Slow Opening** - The accessory relay will cycle and delay both the blower and compressor output for 90 seconds.

- SW2-6** CC Operation – selection of single or dual capacity compressor. On = Single Stage; Off = Dual Capacity
- SW2-7** Lockout and Alarm Outputs (P2) – selection of a continuous or pulsed output for both the LO and ALM Outputs. On = Continuous; Off = Pulsed
- SW2-8** Future Use

### Alarm Jumper Clip Selection

From the factory, ALM is connected to 24 VAC via JW2. By cutting JW2, ALM becomes a dry contact connected to ALG.

### ECM Blower Speeds

The blower speeds can be changed either by using the ECM manual configurations mode method or by using the Aurora AID Tool directly (see Instruction Guide: Aurora Interface and Diagnostics (AID) Tool topic).

### Field Selectable Options via Software

(Selectable via the Aurora AID Tool)

#### ECM Blower Speeds

An ECM blower motor can be driven directly using the onboard PWM output. Four blower speeds are available, based upon the “G”, Y1 (low), Y2 (high), and Aux input signals to the board. The blower speeds can be changed either by the ECM manual configurations mode method (see ECM Configuration Mode topic) or by using the Aurora AID Tool directly. All four blower speeds can be set to the same speed if desired. Aux blower speed will remain at default or current setting and requires the AID Tool for adjustment.

### Safety Features

The following safety features are provided to protect the compressor, heat exchangers, wiring and other components from damage caused by operation outside of design conditions.

**Fuse** – a 3 amp automotive type plug-in fuse provides protection against short circuit or overload conditions.

**Anti-Short Cycle Protection** – 4 minute anti-short cycle protection for the compressor.

**Random Start** – 5 to 80 second random start upon power up.

**Fault Retry** – in the fault condition, the control will stage off the outputs and then “try again” to satisfy the thermostat Y input call. Once the thermostat input calls are satisfied, the control will continue on as if no fault occurred. If 3 consecutive faults occur without satisfying the thermostat Y input call, then the control will go to Lockout mode.

**Lockout** – when locked out, the blower will operate continuously in “G” speed, and PSC blower motor output will remain on. The Alarm output (ALM) and Lockout output (L) will be turned on. The fault type identification display LED1 (Red) shall flash the fault code. To reset lockout conditions with SW2-8 On, thermostat inputs “Y1”, “Y2”, and “W” must be removed for at least 3 seconds. To reset lockout conditions with SW2-8 Off, thermostat inputs “Y1”, “Y2”, “W”, and “DH” must be removed for at least 3 seconds. Lockout may also be reset by turning power off for at least 30 seconds or by enabling the emergency shutdown input for at least 3 seconds.

**Lockout With Emergency Heat** - if the control is locked out in the heating mode, and a Y2 or W input is received, the control will operate in the emergency heat mode while the compressor is locked out. The first emergency heat output will be energized 10 seconds after the W input is received, and the blower will shift to high speed. If the control remains locked out, and the W input is present, additional stage of emergency heat will stage on after 2 minutes. When the W input is removed, all of the emergency heat outputs will turn off, and the ECM blower will shift to “G” speed and PSC blower motor output will remain on.

**High Pressure** – fault is recognized when the Normally Closed High Pressure Switch, P4-9/10 opens, no matter how momentarily. The High Pressure Switch is electrically in series with the Compressor Contactor and serves as a hard-wired limit switch if an overpressure condition should occur.

**Low Pressure** - fault is recognized when the Normally Closed Low Pressure Switch, P4-7/8 is continuously open for 30 seconds. Closure of the LPS any time during the 30 second recognition time restarts the 30 second continuous open requirement. A continuously open LPS shall not be recognized during the 2 minute startup bypass time.

**Loss of Charge** – fault is recognized when the Normally Closed Low Pressure Switch, P4-7/8 is open prior to the compressor starting.

**Condensate Overflow** - fault is recognized when the impedance between this line and 24 VAC common or chassis ground drops below 100K ohms for 30 seconds continuously.

**Freeze Detection (Coax)** - set points shall be either 30°F or 15°F. When the thermistor temperature drops below the selected set point, the control shall begin counting down the 30 seconds delay. If the thermistor value rises above the selected set point, then the count should reset. The resistance value must remain below the selected set point for the entire length of the appropriate delay to be recognized as a fault. This fault will be ignored for the initial 2 minutes of the compressor run time.

**Freeze Detection (Air Coil)** - uses the FP2 input to protect against ice formation on the air coil. The FP2 input will operate exactly like FP1 except that the set point is 30 degrees and is not field adjustable.

## Controls - Aurora Base Control cont.

**Over/Under Voltage Shutdown** - An over/under voltage condition exists when the control voltage is outside the range of 18 VAC to 30 VAC. If the over/under voltage shutdown lasts for 15 minutes, the lockout and alarm relay will be energized. Over/under voltage shutdown is self-resetting in that if the voltage comes back within range of 18 VAC to 30 VAC for at least 0.5 seconds, then normal operation is restored.

### Operation Description

**Power Up** - The unit will not operate until all the inputs and safety controls are checked for normal conditions. The unit has a 5 to 80 second random start delay at power up. Then the compressor has a 4 minute anti-short cycle delay after the random start delay.

Standby In standby mode, Y1, Y2, W, DH, and G are not active. Input O may be active. The blower and compressor will be off.

### Heating Operation

**Heating, 1st Stage (Y1)** - The blower is started on "G" speed immediately and the compressor is energized 10 seconds after the Y1 input is received. The ECM blower motor is switched to low speed 15 seconds after the Y1 input.

**Heating, 2nd Stage (Y1, Y2)** - The compressor will be staged to full capacity 20 seconds after Y2 input is received. The ECM blower will shift to high speed 15 seconds after the Y2 input is received.

**Heating, 3rd Stage (Y1, Y2, W)** - The hot water pump is de-energized and the first stage of electric heat is energized 10 seconds after the W command is received. If the demand continues the second stage of electric heat will be energized after 5 minutes.

**Emergency Heat (W)** - The blower will be started on "G" speed, 10 seconds later the first stage of electric heat will be turned on. 5 seconds after the first stage of electric heat is energized the blower will shift to Aux speed. If the emergency heat demand is not satisfied after 2 minutes the second electric heat stage will be energized.

**Blower (G)** - The blower will start immediately upon receiving a thermostat G command. If there are no other commands from the thermostat the ECM will run on "G" speed until the G command is removed. Regardless of blower input (G) from the thermostat, the blower will remain on for 30 seconds at the end of each heating cycle.

### Cooling Operation

In all cooling operations, the reversing valve directly tracks the O input. Thus, anytime the O input is present, the reversing valve will be energized.

**Cooling, 1st Stage (Y1, O)** - The blower is started on "G" speed immediately and the compressor is energized 10 seconds after the Y1 input is received. The ECM blower motor is switched to low speed 15 seconds after the Y1 input.

**Cooling, 2nd Stage (Y1, Y2, O)** - The compressor will be staged to full capacity 20 seconds after Y2 input is received. The ECM blower will shift to high speed 15 seconds after the Y2 input is received.

**Blower (G)** - The blower will start immediately upon receiving a thermostat G command. If there are no other commands from the thermostat the ECM will run on "G" speed until the G command is removed. Regardless of blower input (G) from the thermostat, the blower will remain on for 30 seconds at the end of each heating, cooling, and emergency heat cycle.

**Dehumidification (Y1, O, DH or Y1, Y2, O, DH)** - When a DH command is received from the thermostat during a compressor call for cooling the ECM blower speed will be reduced by 15% to increase dehumidification.

**Emergency Shutdown** - Four (4) seconds after a valid ES input, P2-7 is present, all control outputs will be turned off and remain off until the emergency shutdown input is no longer present. The first time that the compressor is started after the control exits the emergency shutdown mode, there will be an anti-short cycle delay followed by a random start delay. Input must be tied to common to activate.

**Continuous Blower Operation** - The blower output will be energized any time the control has a G input present, unless the control has an emergency shutdown input present. The blower output will be turned off when G input is removed.

**Load Shed** - The LS input disables all outputs with the exception of the blower output. When the LS input has been cleared, the anti-short cycle timer and random start timer will be initiated. Input must be tied to common to activate.

## Controls - Aurora Base Control cont.

### Aurora 'Base' Control LED Displays

These three LEDs display the status, configuration, and fault codes for the control. These can also be read in plain English via the Aurora AID Tool.

#### Status LED (LED3, Green)

Description of Operation	Fault LED, Green
Normal Mode	ON
Control is Non-functional	OFF
Test Mode	Slow Flash
Lockout Active	Fast Flash
Dehumidification Mode	Flash Code 2
(Future Use)	Flash Code 3
(Future Use)	Flash Code 4
Load Shed	Flash Code 5
ESD	Flash Code 6
(Future Use)	Flash Code 7

#### Configuration LED (LED2, Yellow)

Description of Operation	Configuration LED, Yellow
No Software Overwritten	Flashing ECM Setting
DIP Switch was Overwritten	Slow Flash
ECM Configuration Mode	Fast Flash

#### Fault LED (LED1, Red)

Red Fault LED		LED Flash Code*	Lockout	Reset/Remove
ABC Basic Faults	Normal - No Faults	OFF	-	
	Fault - Input	1	No	Auto
	Fault - High Pressure	2	Yes	Hard or Soft
	Fault - Low Pressure	3	Yes	Hard or Soft
	Fault - Freeze Detection FP2	4	Yes	Hard or Soft
	Fault - Freeze Detection FP1	5	Yes	Hard or Soft
	Fault - Condensate Overflow	7	Yes	Hard or Soft
	Fault - Over/Under Voltage	8	No	Auto
	Fault - FP1 & FP2 Sensor Error	11	Yes	Hard or Soft

**NOTE:** All codes >11 use long flash for tens digit and short flash for the ones digit. 20, 30, 40, 50, etc. are skipped.

### Aurora Interface and Diagnostics (AID) Tool

The Aurora Interface and Diagnostics (AID) Tool is a device that is a member of the Aurora network. The AID Tool is used to troubleshoot equipment which uses the Aurora control via Modbus RTU communication. The AID Tool provides diagnostics, fault management, ECM setup, and system configuration capabilities to the Aurora family of controls. An AID Tool is recommended, although not required, for ECM airflow settings. The AID Tool simply plugs into the exterior of the cabinet in the AID Tool port.



### ABC Control Board Layout

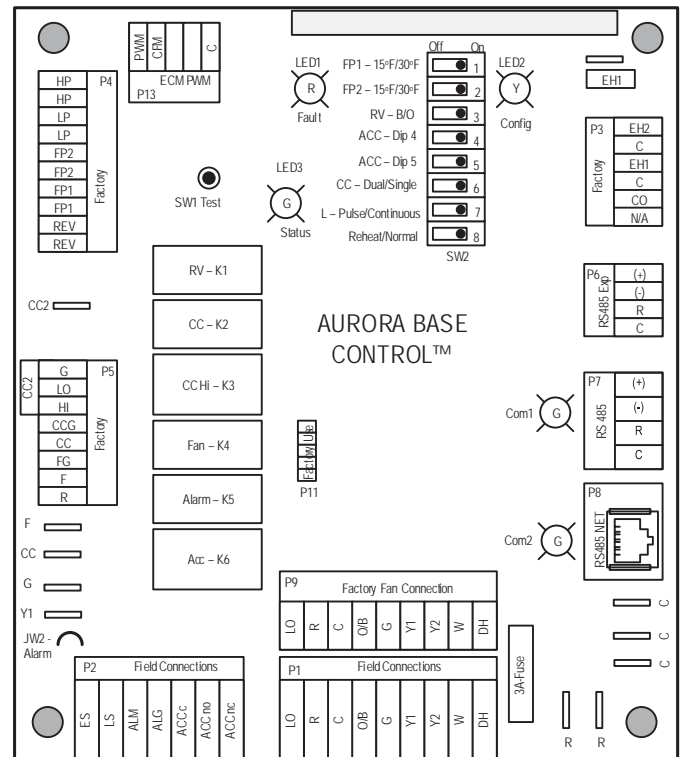

## Application Notes

### The Closed Loop Heat Pump Concept

The basic principle of a water source heat pump is the transfer of heat into water from the space during cooling, or the transfer of heat from water into the space during heating. Extremely high levels of energy efficiency are achieved as electricity is used only to move heat, not to produce it. Using a typical GeoStar Arbor Compact Series, one unit of electricity will move four to five units of heat.

When multiple water source heat pumps are combined on a common circulating loop, the ultimate in energy efficiency is created: The GeoStar units on cooling mode are adding heat to the loop which the units in heating mode can absorb, thus removing heat from the area where cooling is needed, recovering and redistributing that heat for possible utilization elsewhere in the system. In modern commercial structures, this characteristic of heat recovery from core area heat generated by lighting, office equipment, computers, solar radiation, people or other sources, is an important factor in the high efficiency and low operating costs of GeoStar closed source heat pump systems.

In the event that a building's net heating and cooling requirements create loop temperature extremes, Arbor Compact Series units have the extended range capacity and versatility to maintain a

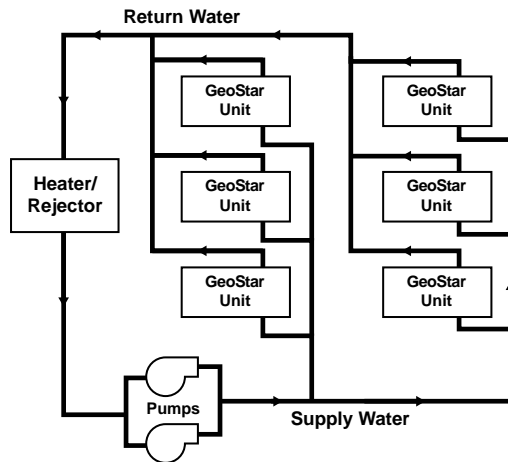

comfortable environment for all building areas. Excess heat can be stored for later utilization or be added or removed in one of three ways; by ground-source heat exchanger loops: plate heat exchangers connected to other water sources, or conventional cooler/boiler configurations. Your GeoStar representative has the expertise and computer software to assist in determining optimum system type for specific applications.

### The Closed Loop Advantage

A properly applied water source heat pump system offers many advantages over other systems. First costs are low because units can be added to the loop on an "as needed basis"- perfect for speculative buildings. Installed costs are low since units are self-contained and can be located adjacent to the occupied

space, requiring minimal ductwork. Maintenance can be done on individual units without system shut-down. Conditions remain comfortable since each unit operates separately, allowing cooling in one area and heating in another. Tenant spaces can be finished and added as needed. Power billing to tenants is also convenient since each unit can be individually metered: each pays for what each uses. Nighttime and/or weekend uses of certain areas are possible without heating or cooling the entire facility. A decentralized system also means if one unit should fault, the rest of the system will continue to operate normally, as well as eliminating air cross-contamination problems and expensive high pressure duct systems requiring an inefficient electric resistance reheat mode.

### The Arbor Compact Approach

There are a number of proven choices in the type of Arbor Compact Series system which would be best for any given application. Most often considered are:

#### Vertical - Closed Loop/Ground Source



- Closed Loop/Ground-Source Systems utilize the stable temperatures of the earth to maintain proper water source temperatures (via vertical or horizontal closed loop heat exchangers) for Arbor Compact Series extended range heat pump system. Sizes range from a single unit through many hundreds of units. When net cooling requirements cause closed loop water temperatures to rise, heat is dissipated into the cooler earth through buried high strength plastic pipe "heat exchangers." Conversely if net space heating demands cause loop heat absorption beyond that heat recovered from building core areas, the loop temperature will fall causing heat to be extracted from the earth. Due to the extended loop temperatures, AHRI/ISO 13256-1 Ground Loop Heat Pumps are required for this application. Because auxiliary equipment such as a fossil fuel boiler and cooling tower are not required to maintain the loop temperature, operating and maintenance costs are very low.

## Application Notes cont.

Ground-source systems are most applicable in residential and light commercial buildings where both heating and cooling are desired, and on larger envelope dominated structures where core heat recovery will not meet overall heating loads. Both vertical and horizontally installed closed-loops can be used. The land space required for the "heat exchangers" is 100-250 sq. ft./ton on vertical (drilled) installations and 750-1500 sq. ft./ton for horizontal (trenched) installations. Closed loop heat exchangers can be located under parking areas or even under the building itself.

On large multi-unit systems, sizing the closed loop heat exchanger to meet only the net heating loads and assisting cooling loads with a closed circuit cooling tower may be the most cost effective choice.

### Surface Water - Closed Loop/Ground Source



- Closed Loop/Ground-Source Surface Water Systems also utilize the stable temperatures of Surface Water to maintain proper water source temperatures for Arbor Compact Series extended range heat pump systems. These systems have all of the advantages of horizontal and vertical closed loop systems. Due to the extended loop temperatures, AHRI/ISO 13256-1 Ground Water or Ground Loop Heat Pumps are required for this application.

In cooling dominated structures, the ground-source surface water systems can be very cost effective especially where local building codes require water retention ponds for short term storage of surface run-off. Sizing requirements for the surface water is a minimum of 500 sq. ft./ton of surface area at a minimum depth of 8 feet. GeoStar should be contacted when designs for heating dominated structures are required.

### Plate Heat Exchanger - Closed Loop/Ground Water

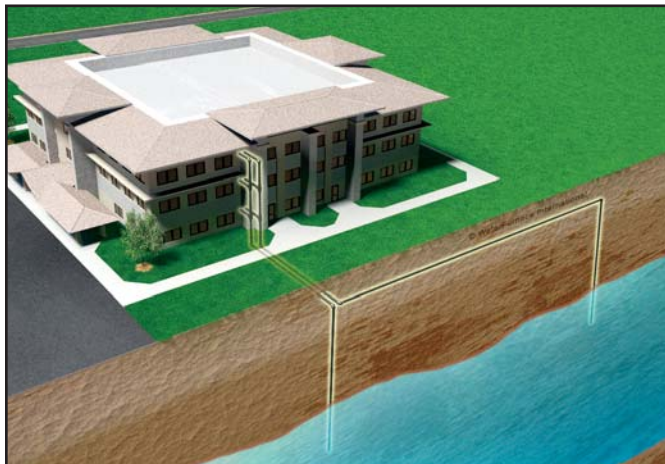

- Closed Loop/Ground Water Plate Heat Exchanger Systems utilize lake, ocean, well water or other water sources to maintain closed loop water temperatures in multi-unit Arbor Compact systems. A plate frame heat exchanger isolates the units from any contaminating effects of the water source, and allows periodic cleaning of the heat exchanger during off peak hours.

Operation and benefits are similar to those for ground-source systems. Due to the extended loop temperatures, AHRI/ISO 13256-1 Ground Loop Heat Pumps are required for this application. Closed loop plate heat exchanger systems are applicable in commercial, marine, or industrial structures where the many benefits of a water source heat pump system are desired, regardless of whether the load is heating or cooling dominated.

## Application Notes cont.

### Cooler/Boiler - Closed Loop



- Closed Loop /Cooler-Boiler Systems utilize a closed heat recovering loop with multiple water source heat pumps in the more conventional manner. Typically a boiler is employed to maintain closed loop temperatures above 60°F and a cooling tower to maintain loop temperatures below 90°F. These systems are applicable in medium to large buildings regardless of whether the load is heating or cooling dominated. Due to the moderate loop temperatures, AHRI/ISO 13256-1 Water Loop Heat Pumps are required for this application.

## Water Quality

In ground water situations where scaling could be heavy or where biological growth such as iron bacteria will be present, a closed loop system is recommended. The heat exchanger coils in ground water systems may, over a period of time, lose heat exchange capabilities due to a buildup of mineral deposits inside. These can be cleaned, but only by a qualified service mechanic, as special solutions and pumping equipment are required. Hot water generator coils can likewise become scaled and possibly plugged.

In areas with extremely hard water, the owner should be informed that the heat exchanger may require occasional flushing. Failure to adhere to the guidelines in the water quality table could result in loss of warranty.

Units with cupronickel heat exchangers are recommended for open loop applications due to the increased resistance to build-up and corrosion, along with reduced wear caused by acid cleaning.

Material		Copper	90/10 Cupronickel	316 Stainless Steel
pH	Acidity/Alkalinity	7 - 9	7 - 9	7 - 9
Scaling	Calcium and Magnesium Carbonate	(Total Hardness) less than 350 ppm	(Total Hardness) less than 350 ppm	(Total Hardness) less than 350 ppm
Corrosion	Hydrogen Sulfide	Less than 0.5 ppm (rotten egg smell appears at 0.5 ppm)	10 - 50 ppm	Less than 1 ppm
	Sulfates	Less than 125 ppm	Less than 125 ppm	Less than 200 ppm
	Chlorine	Less than 0.5 ppm	Less than 0.5 ppm	Less than 0.5 ppm
	Chlorides	Less than 20 ppm	Less than 125 ppm	Less than 300 ppm
	Carbon Dioxide	Less than 50 ppm	10 - 50 ppm	10 - 50 ppm
	Ammonia	Less than 2 ppm	Less than 2 ppm	Less than 20 ppm
	Ammonia Chloride	Less than 0.5 ppm	Less than 0.5 ppm	Less than 0.5 ppm
	Ammonia Nitrate	Less than 0.5 ppm	Less than 0.5 ppm	Less than 0.5 ppm
	Ammonia Hydroxide	Less than 0.5 ppm	Less than 0.5 ppm	Less than 0.5 ppm
	Ammonia Sulfate	Less than 0.5 ppm	Less than 0.5 ppm	Less than 0.5 ppm
	Total Dissolved Solids (TDS)	Less than 1000 ppm	1000 - 1500 ppm	1000 - 1500 ppm
	LSI Index	+0.5 to -0.5	+0.5 to -0.5	+0.5 to -0.5
Iron Fouling (Biological Growth)	Iron, FE <sup>2+</sup> (Ferrous) Bacterial Iron Potential	< 0.2 ppm	< 0.2 ppm	< 0.2 ppm
	Iron Oxide	Less than 1 ppm, above this level deposition will occur	Less than 1 ppm, above this level deposition will occur	Less than 1 ppm, above this level deposition will occur
Erosion	Suspended Solids	Less than 10 ppm and filtered for max. of 600 micron size	Less than 10 ppm and filtered for max. of 600 micron size	Less than 10 ppm and filtered for max. of 600 micron size
	Threshold Velocity (Fresh Water)	< 6 ft/sec	< 6 ft/sec	< 6 ft/sec

NOTES: Grains = ppm divided by 17  
mg/L is equivalent to ppm

2/22/12

## Installation Notes

### Typical Unit Installation

#### Unit Location

Locate the unit in an indoor area that allows for easy removal of the filter and access panels. Location should have enough space for service personnel to perform maintenance or repair. Provide sufficient room to make water, electrical and duct connection(s). If the unit is located in a confined space, such as a closet, provisions must be made for return air to freely enter the space by means of a louvered door, etc. Any access panel screws that would be difficult to remove after the unit is installed should be removed prior to setting the unit. On horizontal units, allow adequate room below the unit for a condensate drain trap and do not locate the unit above supply piping. Care should be taken when units are located in unconditioned spaces to prevent damage from frozen water lines and excessive heat that could damage electrical components.

#### Water Piping

Piping is usually design as 'reverse return' to equalize flow paths through each unit. A short flexible pressure rated hose is used to

make connection to the fixed building piping system. This hose is typically stainless steel braid and includes a swivel fitting on one end for easy removal and is flexible to help isolate the unit for quieter operation. Isolation valves for servicing, y-strainers for filtering and memory-stop flow valve or a balancing valve can be provided for consistent water flow through the unit.

All unit source water connections are fittings that accept a male pipe thread (MPT). Insert the connectors by hand, then tighten the fitting with a wrench to provide a leakproof joint. The open and closed loop piping system should include pressure/temperature ports for serviceability. The proper water flow must be provided to each unit whenever the unit operates. To assure proper flow, use pressure/temperature ports to determine the flow rate. These ports should be located at the supply and return water connections on the unit. The proper flow rate cannot be accurately set without measuring the water pressure drop through the refrigerant-to-water heat exchanger. Never use flexible hoses smaller than the inside diameter of the water connection at the unit. Limit hose length to 10 feet per connection. Check carefully for water leaks.

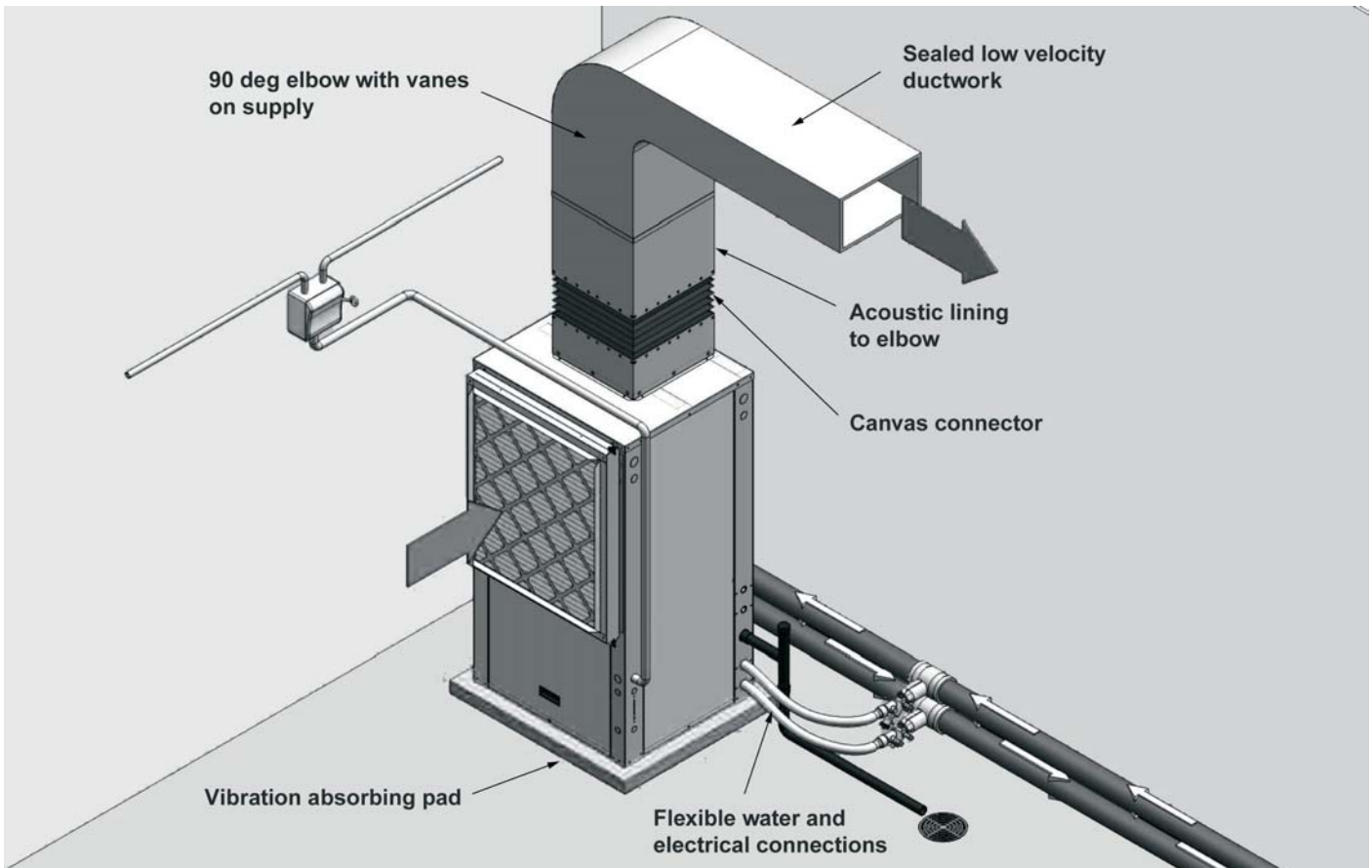

## Installation Notes cont.

### Installing Horizontal Units

Remove and discard the compressor hold down shipping bolt or screw located at the front or side (side, horizontal only) of the compressor mounting bracket prior to setting the unit in place. Horizontal units are available with side or end discharge.

**NOTE:** Left (Right) Return Side Discharge cannot be converted to Left (Right) Return End Discharge or vice versa, without additional custom sheet metal parts. Horizontal units are normally suspended from a ceiling by four 3/8 in. diameter threaded rods. The rods are usually attached to the unit by hanger bracket kits furnished with each unit.

Lay out the threaded rods per the Hanger Bracket Dimensions table. Assemble the hangers to the unit as shown. Securely tighten the brackets to the unit using the weld nuts located on the underside of the bottom panel. When attaching the hanger rods to the bracket, a double nut is required since vibration could loosen a single nut. To allow filter access, install hanger brackets as illustrated in the Hanger Bracket Locations section. The unit

should be pitched approximately 1/4 in. towards the drain in both directions to facilitate the removal of condensate. Use only the bolts provided in the kit to attach hanger brackets. The use of longer bolts could damage internal parts.

Some applications require the installation of horizontal units on an attic floor. In this case, the unit should be set in a full size secondary drain pan on top of a vibration absorbing pad. The secondary drain pan prevents possible condensate overflow or water leakage damage to the ceiling. The secondary drain pan is usually placed on a plywood base isolated from the ceiling joists by additional layers of vibration absorbing material.



**CAUTION:** Do not use rods smaller than 3/8 in. diameter since they may not be strong enough to support the unit. The rods must be securely anchored to the ceiling.

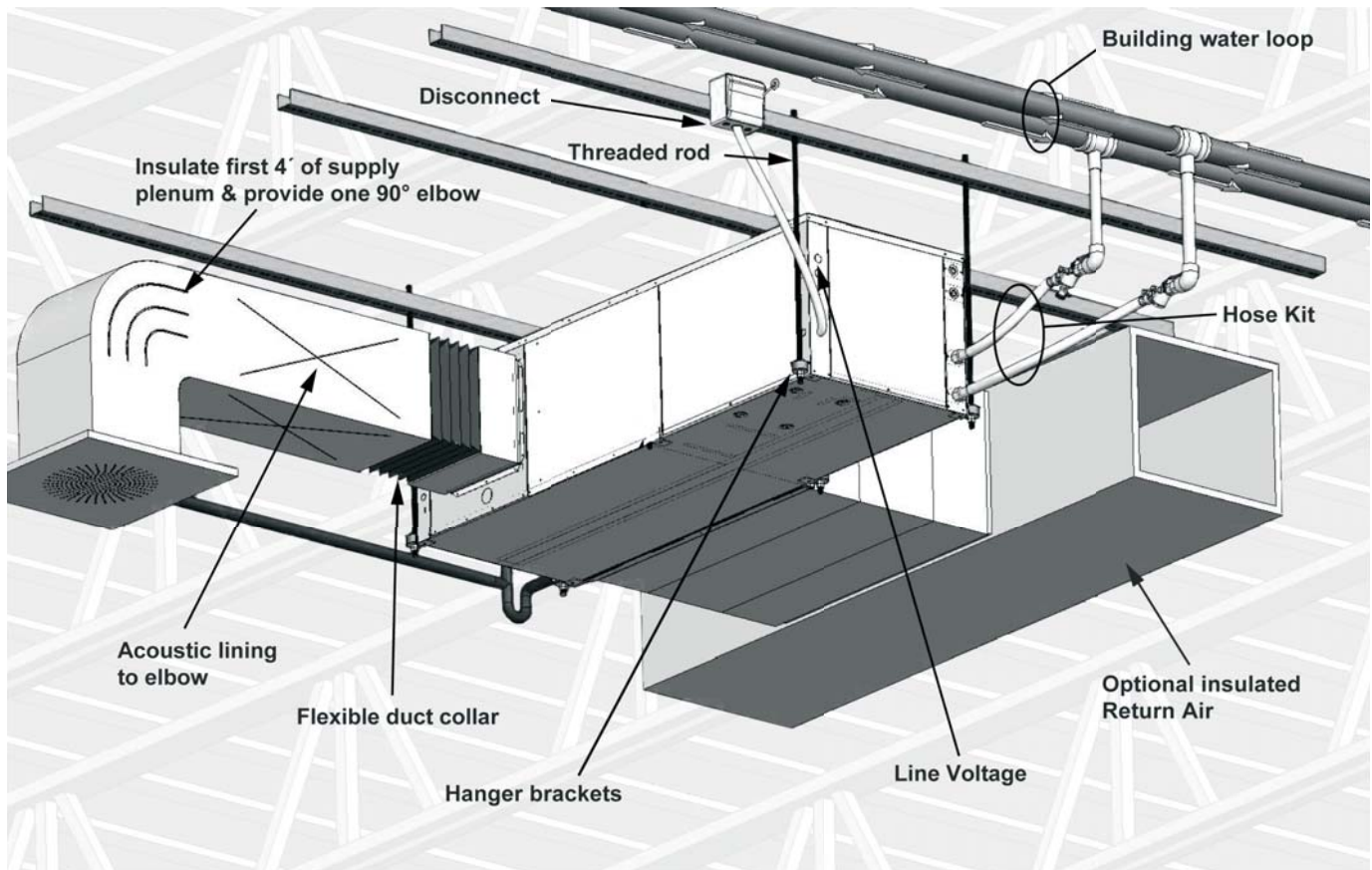



## Installation Notes cont.

### Acoustical Considerations and Equipment Sound Performance

#### Sound Performance

The Arbor Compact Series is third party sound rated in accordance with ARI 260. Please consult GeoStar Sound Performance Data Catalog for details on the AHRI standard and sound performance data.

#### Recommendations for Noise Reduction

##### Horizontal Unit Location

- Specify equipment with quietest sound power ratings
- Do not locate units above areas with a required NC 40 or less
- Space WSHP at least 10 ft (3m) apart to avoid noise summing of multiple units in a space.
- Maximize the height of the unit above the ceiling (horizontal).
- Suspend unit with isolation grommets that are appropriately rated to reduce vibrations (horizontal).

##### Vertical Unit Location

- Specify equipment with quietest sound power ratings
- Space WSHP at least 10 ft (3m) apart to avoid noise summing of multiple units in a space.
- Acoustic ceiling coatings can greatly reduce noise levels in mechanical rooms.
- Mount unit on a sound absorbing pad, extruded polystyrene, rubber or cork pad.

#### Ductwork

- Ensure return air grilles will not allow line of site noise to transfer to adjacent space. Use a sound barrier or some other material to isolate the grille from the unit. A supply grille, boot and short piece of flex duct pointed away from the unit can greatly attenuate equipment noise.
- Use a canvas isolation duct connector at the supply and return duct connection of the unit.
- Internally line the discharge and return duct within the first 4-8 feet of unit with acoustic insulation. Install an internally lined 'L' shaped return duct elbow at return grille. Face the elbow away from adjacent units.
- Always install at least one 90° elbow in the discharge duct to eliminate line of sight noise transmission of the blower.
- Use turning vanes at all elbows and tees to reduce turbulence.
- Limit supply duct velocities to less than 1,000 fpm
- Design and install ductwork as stiff as possible
- Allow 3 duct diameters both up and down stream of the unit before any fittings or transitions are installed.
- Use duct sealant on all duct joints.
- Install a short (2-4') of flex duct on all branch ducts just prior to discharge boot or diffuser to reduce vibration and duct sound prior to delivery in the room.
- Locate the branch duct balancing damper as far away from the diffuser as possible.
- In ceiling plenum systems, install an internally lined 'L' shaped return duct elbow at unit. Face the elbow away

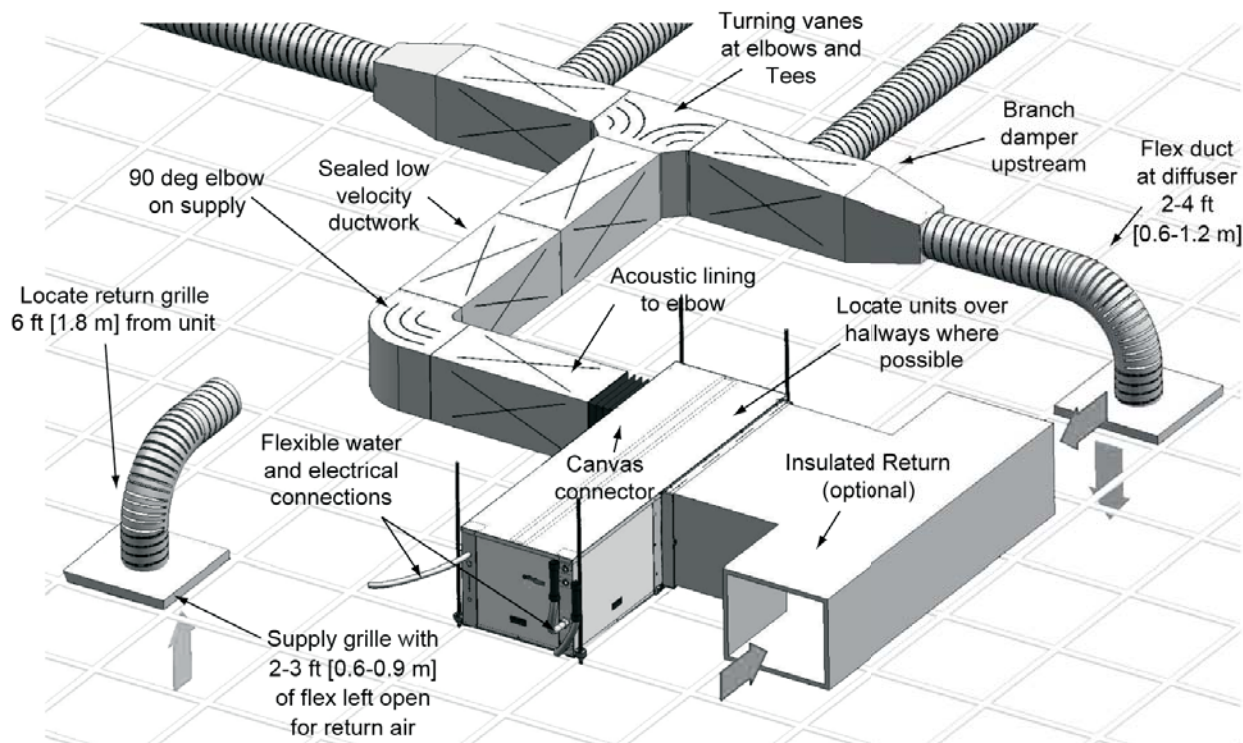

# Vertical Dimensional Data

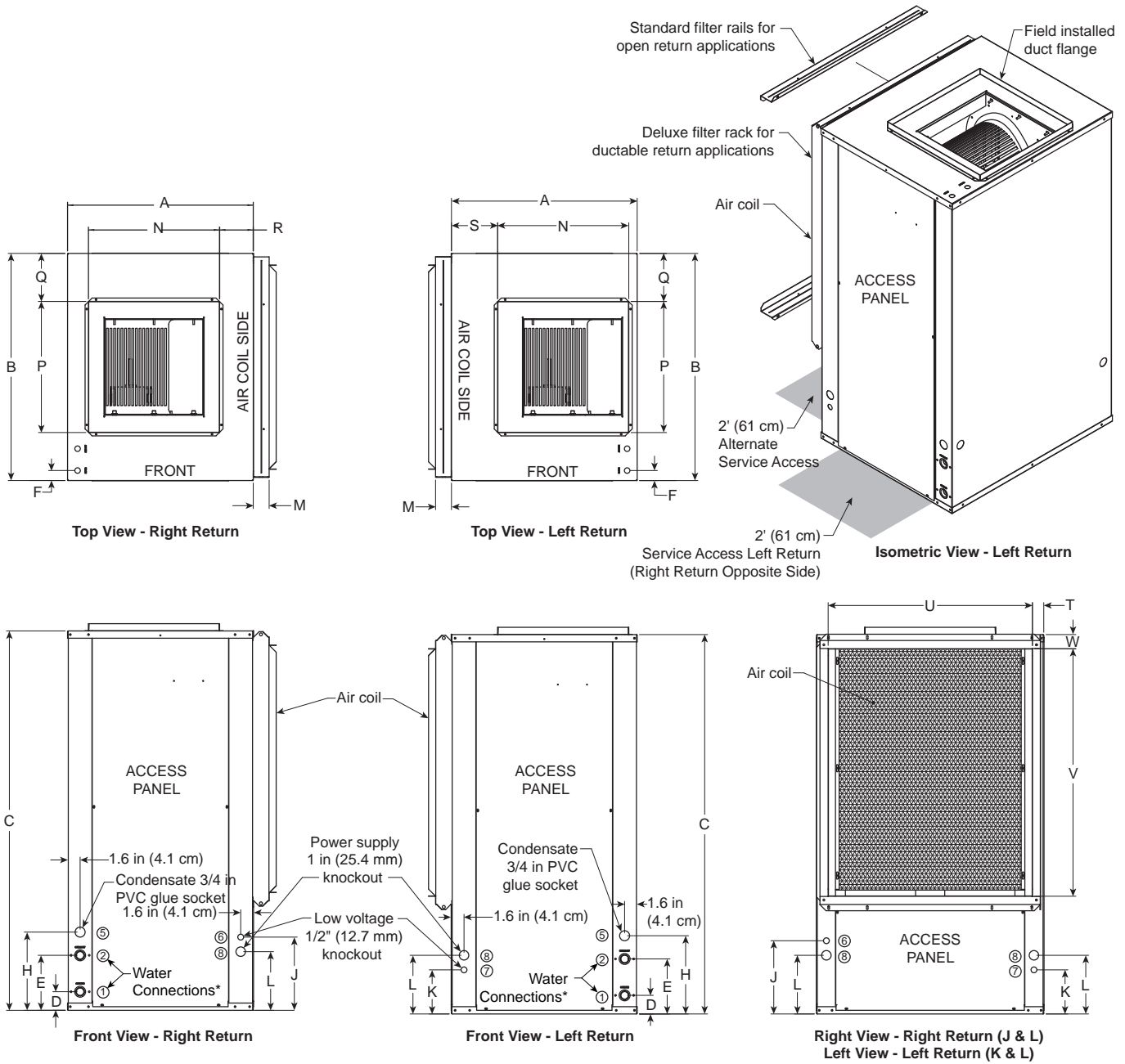

**NOTE:** \* Water connections protrude approximately 1.5 in. (3.81cm) from cabinet.

## Vertical Dimensional Data cont.

Vertical Models		Overall Cabinet			Water Connections				Electrical Knockouts			M
									6	7	8	
		A	B	C	1	2	5	Loop	J	K	L	
		Width	Depth	Height*	D	E	H	Water FPT	1/2" cond	1/2" cond	1" cond	Filter Rack Width
					In	Out	Condensate		Low Voltage	Low Voltage	Power Supply	
006-012	in.	19.2	19.2	24.2	2.6	5.6	8.8	1/2"	7.4	3.4	5.4	2.2
	cm.	48.8	48.8	61.5	6.6	14.2	22.4	12.7 mm	18.8	8.6	13.7	5.6
015-018	in.	22.5	22.2	30.2	2.6	7.6	10.8	3/4"	9.4	5.4	7.4	2.2
	cm.	57.2	56.4	76.7	6.6	19.3	27.4	19.1 mm	23.9	13.7	18.8	5.6
024-030	in.	22.5	22.2	36.2	2.6	7.6	10.8	3/4"	9.4	5.4	7.4	2.2
	cm.	57.2	56.4	91.9	6.6	19.3	27.4	19.1 mm	23.9	13.7	18.8	5.6
036	in.	22.5	26.2	40.2	2.6	7.6	10.8	3/4"	10.1	6.1	8.1	2.2
	cm.	57.2	66.5	102.1	6.6	19.3	27.4	19.1 mm	25.7	15.5	20.6	5.6
041	in.	21.5	21.5	40.2	2.6	7.6	10.8	3/4"	9.4	5.4	7.4	1.2
	cm.	54.6	54.6	102.1	6.6	19.3	27.4	19.1 mm	23.9	13.7	18.8	3.0
042-048	in.	22.5	26.2	44.2	2.6	7.6	10.8	3/4"	10.1	6.1	8.1	2.2
	cm.	57.2	66.5	112.3	6.6	19.3	27.4	19.1 mm	25.7	15.5	20.6	5.6
060	in.	25.5	31.2	44.2	2.6	7.6	10.8	1"	10.1	6.1	8.1	2.2
	cm.	64.8	79.2	112.3	6.6	19.3	27.4	25.4 mm	25.7	15.5	20.6	5.6
070	in.	25.5	31.2	48.2	2.6	7.6	10.8	1"	10.1	6.1	8.1	2.2
	cm.	64.8	79.2	122.4	6.6	19.3	27.4	25.4 mm	25.7	15.5	20.6	5.6

Vertical Models		Discharge Connection duct flange installed (±0.10 in)					**Return Connection using deluxe filter rack (±0.10 in)			
		N	P	Q	R	S	T	U	V	W
		Supply Width	Supply Depth					Return Depth	Return Height	
006-012	in.	10.0	10.0	4.6	4.4	7.8	2.4	14.3	10.1	2.0
	cm.	25.4	25.4	11.7	11.2	19.8	6.1	36.3	25.7	5.1
015-018	in.	14.0	14.0	4.1	4.3	7.7	2.1	18.1	14.0	2.0
	cm.	35.6	35.6	10.4	10.9	19.6	5.3	46.0	35.6	5.1
024-030	in.	14.0	14.0	4.1	4.3	7.7	2.1	18.1	20.0	2.0
	cm.	35.6	35.6	10.4	10.9	19.6	5.3	46.0	50.8	5.1
036	in.	14.0	14.0	6.1	4.5	7.7	2.1	22.1	22.1	2.0
	cm.	35.6	35.6	15.5	11.4	19.6	5.3	56.1	56.1	5.1
041	in.	14.0	14.0	3.8	3.5	6.7	0.6	20.2	28.0	0.6
	cm.	35.6	35.6	9.7	8.9	17.0	1.5	51.3	71.1	1.5
042-048	in.	18.0	18.0	4.1	2.1	3.9	2.1	22.1	26.1	2.0
	cm.	45.7	45.7	10.4	5.3	9.9	5.3	56.1	66.3	5.1
060	in.	18.0	18.0	6.6	4.6	6.3	1.6	28.1	26.0	2.0
	cm.	45.7	45.7	16.8	11.7	16.0	4.1	71.4	66.0	5.1
070	in.	18.0	18.0	6.6	4.6	6.3	1.6	28.1	30.0	2.0
	cm.	45.7	45.7	16.8	11.7	16.0	4.1	71.4	76.2	5.1

Condensate is 3/4" PVC female glue socket and is switchable from side to front.

10/15/15

\*Discharge flange is field installed and extends 1" (25.4 mm) from top of cabinet.

\*\*Vertical units shipped with standard 2" (field adjustable to 1") open application filter rack extending 2.2" from unit and is not suitable for duct connection. For ductable return connection applications, order the deluxe 2" (field adjustable to 1") duct collar/filter rack which extends 3.25

## Vertical Disconnect

When using disconnect, do not use dimension L from the standard vertical dimensional data. Use dimension LL from the vertical disconnect dimensional data.

Vertical Models	LL
015-018	15.8 [40.1]
024-030	18.8 [47.8]
036	15.3 [38.9]
042-048	13.8 [35.1]
060	14.3 [36.3]
070	14.3 [36.3]

Dimensions in inches [cm]

\* Models 006-012 - Externally Mounted Disconnect

\*\*UBV-041 - Disconnect not available

# Horizontal Dimensional Data

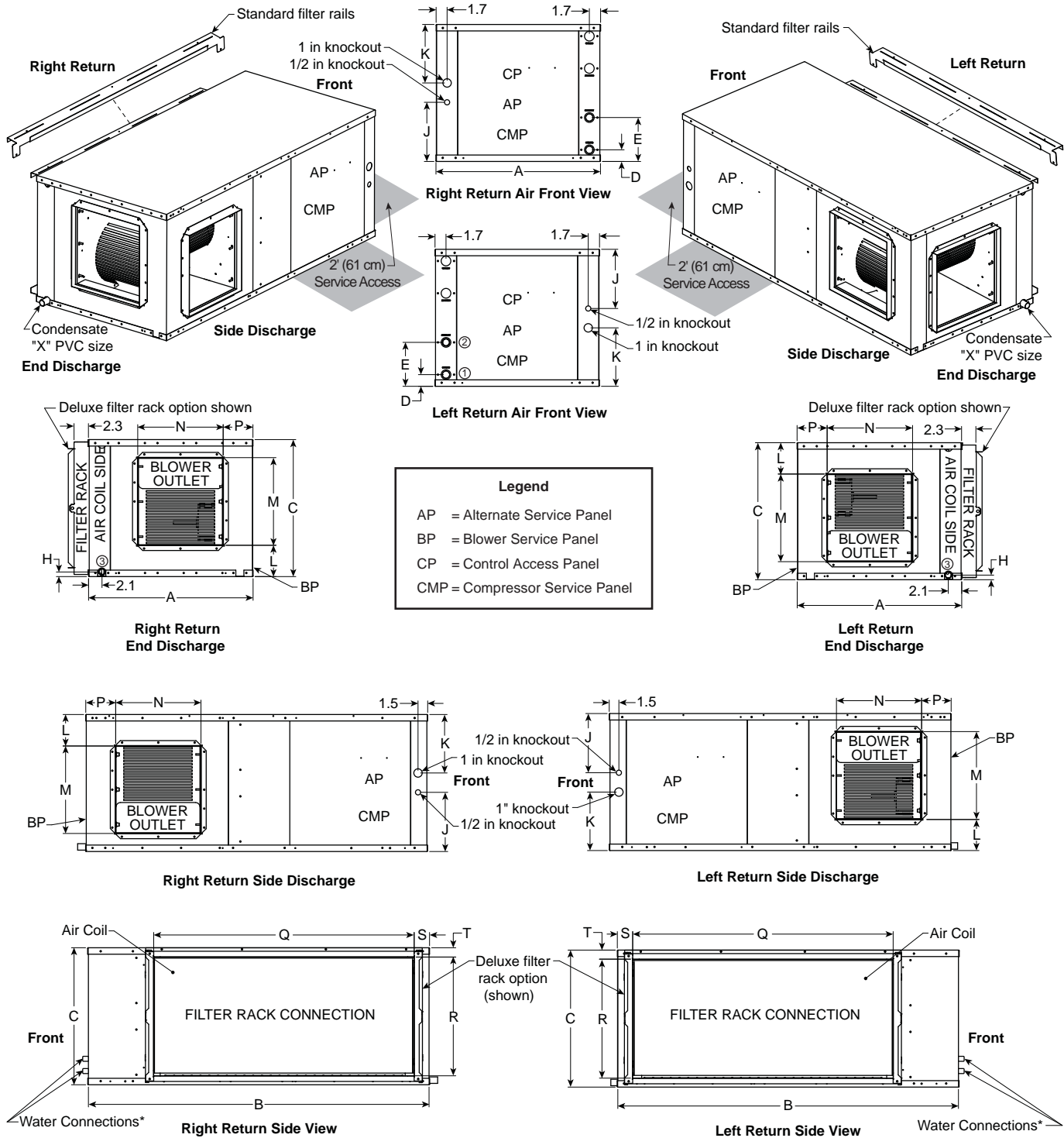

**NOTE:** \* Water connections protrude approximately 1.5 in. from cabinet.

## Horizontal Dimensional Data cont.

Horizontal Models	Overall Cabinet			Water Connections				Electrical Knockouts		
	A	B	C	1	2	3	Loop Water FPT	J	K	
	Width	Depth	Height*	D In	E Out	H Condensate		1/2 in. cond Low Voltage	1 in. cond Power Supply	
006-012**	in.	19.2	35.0	12.1	1.8	4.8	3.6	1/2 in.	7.4	7.5
	cm.	48.8	88.9	30.7	4.6	12.2	9.1	12.70 mm	18.8	19.1
015-018	in.	22.5	35.0	17.2	1.8	6.8	0.8	3/4 in.	7.1	7.1
	cm.	57.2	88.9	43.7	4.6	17.3	2.0	19.05 mm	18.0	18.0
024-030	in.	22.5	42.0	17.2	1.8	6.8	0.8	3/4 in.	7.1	7.1
	cm.	57.2	106.7	43.7	4.6	17.3	2.0	19.05 mm	18.0	18.0
036	in.	22.5	42.0	19.2	1.8	6.8	0.8	3/4 in.	9.2	7.1
	cm.	57.2	106.7	48.8	4.6	17.3	2.0	19.05 mm	23.4	18.0
042-048	in.	22.5	45.0	19.2	1.8	6.8	0.8	3/4 in.	9.2	7.1
	cm.	57.2	114.3	48.8	4.6	17.3	2.0	19.05 mm	23.4	18.0
060	in.	25.5	48.0	21.2	1.8	6.8	0.8	1 in.	9.2	9.1
	cm.	64.8	121.9	53.8	4.6	17.3	2.0	25.4 mm	23.4	23.1
070	in.	25.5	53.0	21.2	1.8	6.8	0.8	1 in.	9.2	9.1
	cm.	64.8	134.6	53.8	4.6	17.3	2.0	25.4 mm	23.4	23.1

Horizontal Models	Discharge Connection duct flange installed (±0.10 in)				Return Connection using deluxe filter rack option (±0.10 in)				PVC Size	
	L	M	N	P	Q	R	S	T	X	
		Supply Width	Supply Depth		Return Depth	Return Height				
006-012**	in.	2.3	8.0	10.0	2.7	22.5	9.4	2.4	1.4	1/2 in.
	cm.	5.8	20.3	25.4	6.9	57.2	23.9	6.1	3.6	1.3
015-018	in.	5.7	10.5	9.4	4.9	16.4	14.5	2.0	1.4	3/4 in.
	cm.	14.5	26.7	23.9	12.4	41.7	36.8	5.1	3.6	1.9
024-030	in.	5.7	10.5	9.4	4.9	23.4	14.5	2.0	1.4	3/4 in.
	cm.	14.5	26.7	23.9	12.4	59.4	36.8	5.1	3.6	1.9
036	in.	6.7	10.5	9.4	4.9	27.4	16.5	2.0	1.4	3/4 in.
	cm.	17.0	26.7	23.9	12.4	69.6	41.9	5.1	3.6	1.9
042-048	in.	4.2	13.6	13.2	2.4	30.4	16.5	2.0	1.5	3/4 in.
	cm.	10.7	34.5	33.5	6.1	77.2	41.9	5.1	3.8	1.9
060	in.	4.8	13.6	13.2	4.6	35.4	18.7	2.3	1.3	3/4 in.
	cm.	12.2	34.5	33.5	11.7	89.9	47.5	5.8	3.3	1.9
070	in.	4.8	13.6	13.2	4.6	40.4	18.5	2.3	1.4	3/4 in.
	cm.	12.2	34.5	33.5	11.7	102.6	47.0	5.8	3.6	1.9

Horizontal units shipped with standard 2 in. (field adjustable to 1 in.) open application filter rail extending 2.2 in. from the unit and is not suitable for duct connection. For ductable return connection applications, order the 2 in. (field adjustable to 1 in.) duct collar/filter rack which extends to 3.25 in. from the unit and is suitable for duct connections.

09/26/12

\*\* H006-012 offers a lifted drain pan that allows the trap to be installed without additional ceiling height required.

## Horizontal Disconnect

When using disconnect, do not use dimension K from the standard horizontal dimensional data. Use dimension KK from the horizontal disconnect dimensional data.

Horizontal Models	KK
015-018	8.2 [20.8]
024-030	8.2 [20.8]
036	9.2 [23.4]
042-048	9.2 [23.4]
060	11.2 [28.4]
070	10.2 [25.9]

Dimensions in inches [cm]

\* Models 006-012 - Externally Mounted Disconnect

# Hanger Bracket Locations

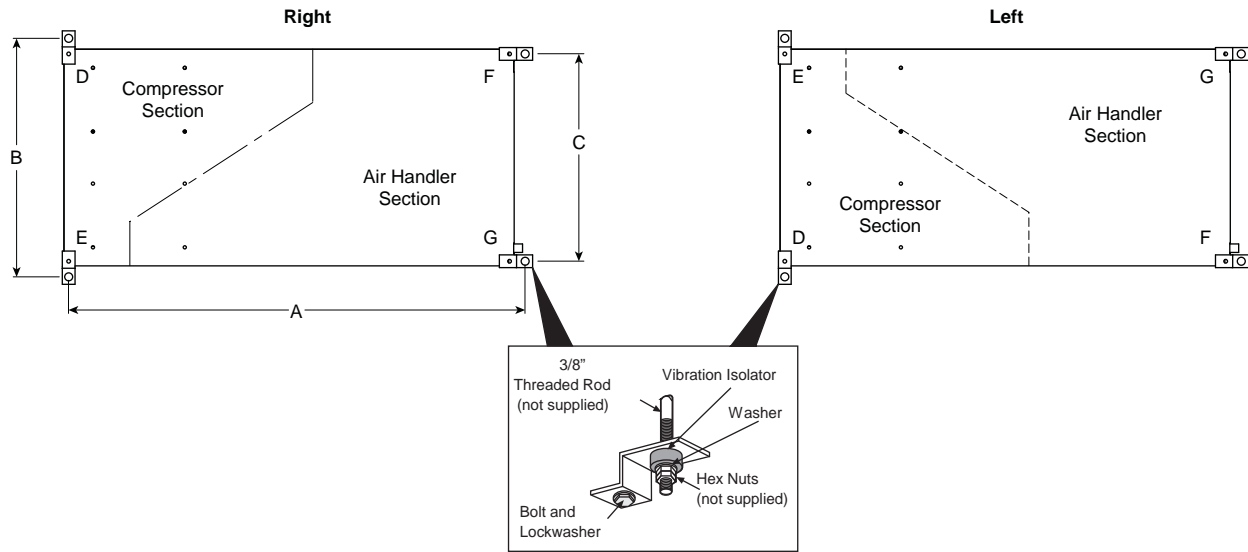

## Hanger Dimensions

Model	Hanger Kit Part Number	Unit Hanger Dimensions			
		A	B	C	
006-012	99S500A04	in.	35.8	21.8	18.1
		cm.	90.9	55.4	46.0
015-018	99S500A04	in.	35.8	25.1	21.4
		cm.	90.9	63.8	54.4
024-030	99S500A04	in.	42.8	25.1	21.4
		cm.	108.6	63.8	54.4
036	99S500A04	in.	42.8	25.1	21.4
		cm.	108.7	63.8	54.4
042-048	99S500A04	in.	45.8	25.1	21.4
		cm.	116.3	63.8	54.4
060	99S500A04	in.	48.8	28.1	24.4
		cm.	124.0	71.4	62.0
070	99S500A04	in.	53.8	28.1	24.4
		cm.	136.7	71.4	62.0

09/26/12

## Weight Distribution Table

Model	Vertical Shipping Weight	Horizontal Shipping Weight	Horizontal Weight Distribution				
			Front		Back		
			D	E	F	G	
006-012	lbs	111	112	44	21	19	28
	kg	50	51	20	10	9	12
015-018	lbs	171	176	32	67	32	45
	kg	78	80	15	30	15	20
024	lbs	245	242	47	85	45	65
	kg	111	110	21	39	20	29
030	lbs	245	242	47	85	45	65
	kg	111	110	21	39	20	29
036	lbs	267	265	60	95	50	60
	kg	121	120	27	43	23	27
041	lbs	243	N/A				
	kg	110	N/A				
042	lbs	305	310	68	105	60	77
	kg	138	141	31	48	27	35
048	lbs	305	310	68	105	60	77
	kg	138	141	31	48	27	35
060	lbs	344	350	77	115	68	90
	kg	156	159	35	52	31	41
070	lbs	357	378	80	130	73	95
	kg	162	171	36	59	33	43

10/15/2015

# Physical Data

Model	Single Speed Models														
	006	009	012	015	018	024	030	036	041	042	048	060	070		
Compressor (1 each)	Rotary						Scroll								
Factory Charge R410A, oz [kg] Vertical	24 [0.68]	26 [0.74]	26 [0.74]	30 [0.85]	34 [0.96]	*	*	*	*	*	*	*	*		
Factory Charge R410A, oz [kg] Horizontal	24 [0.68]	24 [0.68]	26 [0.74]	30 [0.85]	34 [0.96]	*	*	*	*	*	*	*	*		
<b>Blower Motor &amp; Blower</b>															
Blower Motor Type/Speeds	VS ECM	Variable Speed (Constant Torque)				Variable Speed (Constant CFM)									
	5 Speed ECM	Not Available				5 Speed									
	PSC	4 Speeds				3 Speed									
Blower Motor-hp [W]	VS ECM	1/10 [75]	1/10 [75]	1/10 [75]	1/2 [373]	1/2 [373]	1/2 [373]	1/2 [373]	1/2 [373]	1/2 [373]	1/2 [373]	1 [746]	1 [746]	1 [746]	
	5 Speed ECM	Not Available				1/2 [373]	1/2 [373]	1/2 [373]	1/2 [373]	1/2 [373]	1 [746]	1 [746]	1 [746]	1 [746]	
	PSC	1/10 [75]	1/10 [75]	1/10 [75]	1/6 [134]	1/6 [134]	1/5 [149]	1/3 [249]	1/2 [373]	1/3 [249]	1/2 [373]	1/2 [373]	1 [746]	1 [746]	
Blower Wheel Size (Dia x W), in. [mm]	VS ECM	6 x 8 [152 x 203]	6 x 8 [152 x 203]	6 x 8 [152 x 203]	9 x 7 [229 x 178]	9 x 7 [229 x 178]	9 x 7 [229 x 178]	9 x 7 [229 x 178]	9 x 7 [229 x 178]	9 x 7 [229 x 178]	11 x 10 [279 x 254]	11 x 10 [279 x 254]	11 x 10 [279 x 254]	11 x 10 [279 x 254]	
	5 Speed ECM	Not Available				9 x 7 [229 x 178]	9 x 7 [229 x 178]	9 x 7 [229 x 178]	9 x 7 [229 x 178]	9 x 7 [229 x 178]	9 x 7 [229 x 178]	11 x 10 [279 x 254]	11 x 10 [279 x 254]	11 x 10 [279 x 254]	11 x 10 [279 x 254]
	PSC	6 x 8 [152 x 203]	6 x 8 [152 x 203]	6 x 8 [152 x 203]	9 x 7 [229 x 178]	9 x 7 [229 x 178]	9 x 7 [229 x 178]	9 x 7 [229 x 178]	9 x 7 [229 x 178]	9 x 7 [229 x 178]	10 x 10 [254 x 254]	10 x 10 [254 x 254]	11 x 10 [279 x 254]	11 x 10 [279 x 254]	
<b>Coax and Water Piping</b>															
Water Connection Size - FPT - in [mm]	1/2" [12.7]	1/2" [12.7]	1/2" [12.7]	3/4" [19.1]	3/4" [19.1]	3/4" [19.1]	3/4" [19.1]	3/4" [19.1]	3/4" [19.1]	3/4" [19.1]	3/4" [19.1]	3/4" [19.1]	1" [25.4]	1" [25.4]	
Coax & Piping Water Volume - gal [l]	0.4 [1.49]	0.4 [1.49]	0.4 [1.49]	0.4 [1.49]	0.4 [1.49]	0.4 [1.49]	0.75 [2.83]	0.9 [3.41]	0.9 [3.41]	0.9 [3.41]	0.9 [3.41]	1.25 [4.72]	1.5 [5.68]	1.5 [5.68]	
<b>Vertical</b>															
Air Coil Dimensions (H x W), in. [mm]	12 x 14 [305 x 356]	12 x 14 [305 x 356]	12 x 14 [305 x 356]	16 x 16 [406 x 406]	16 x 16 [406 x 406]	22 x 16 [559 x 406]	22 x 16 [559 x 406]	24 x 20 [610 x 508]	26 x 16 [660 x 406]	28 x 20 [711 x 508]	28 x 20 [711 x 508]	28 x 25 [711 x 635]	32 x 25 [813 x 635]		
Air Coil Total Face Area, ft <sup>2</sup> [m <sup>2</sup> ]	1.17 [0.11]	1.17 [0.11]	1.17 [0.11]	1.8 [0.17]	1.8 [0.17]	2.4 [0.2]	2.4 [0.2]	3.3 [0.307]	2.9 [0.269]	3.9 [0.362]	3.9 [0.362]	4.9 [0.455]	5.6 [0.520]		
Air Coil Tube Size, in [mm]	3/8 [9.5]	3/8 [9.5]	3/8 [9.5]	3/8 [9.5]	3/8 [9.5]	3/8 [9.5]	3/8 [9.5]	3/8 [9.5]	3/8 [9.5]	3/8 [9.5]	3/8 [9.5]	3/8 [9.5]	3/8 [9.5]		
Air Coil Number of rows	3	3	3	3	3	3	3	3	4	3	3	3	3		
Filter Standard - 1" [25mm] MERV4 Throw-away, in [mm]	12 x 16 [305 x 406]	12 x 16 [305 x 406]	12 x 16 [305 x 406]	16 x 20 [406 x 508]	16 x 20 [406 x 508]	22 x 20 [559 x 508]	22 x 20 [559 x 508]	24 x 24 [610 x 610]	28 x 20 [711 x 508]	28 x 24 [711 x 610]	28 x 24 [711 x 610]	28 x 30 [711 x 762]	32 x 30 [813 x 762]		
Filter Standard - 2" [51mm] Pleated MERV13 Throwaway, in [mm]	12 x 16 [305 x 406]	12 x 16 [305 x 406]	12 x 16 [305 x 406]	16 x 20 [406 x 508]	16 x 20 [406 x 508]	22 x 20 [559 x 508]	22 x 20 [559 x 508]	24 x 24 [610 x 610]	N/A	28 x 24 [711 x 610]	28 x 24 [711 x 610]	28 x 30 [711 x 762]	32 x 30 [813 x 762]		
<b>Horizontal</b>															
Air Coil Dimensions (H x W), in. [mm]	8 x 22 [203 x 559]	8 x 22 [203 x 559]	8 x 22 [203 x 559]	16 x 16 [406 x 406]	16 x 16 [406 x 406]	16 x 23 [406 x 584]	16 x 23 [406 x 584]	18 x 27 [457 x 686]	N/A	18 x 30 [457 x 762]	18 x 30 [457 x 762]	20 x 35 [508 x 889]	20 x 40 [508 x 1016]		
Air Coil Total Face Area, ft <sup>2</sup> [m <sup>2</sup> ]	1.22 [0.11]	1.22 [0.11]	1.22 [0.11]	1.8 [0.17]	1.8 [0.17]	2.6 [0.238]	2.6 [0.238]	2.9 [0.269]		3.8 [0.353]	3.8 [0.353]	4.9 [0.455]	5.6 [0.52]		
Air Coil Tube Size, in [mm]	3/8 [9.5]	3/8 [9.5]	3/8 [9.5]	3/8 [9.5]	3/8 [9.5]	3/8 [9.5]	3/8 [9.5]	3/8 [9.5]		3/8 [9.5]	3/8 [9.5]	3/8 [9.5]	3/8 [9.5]		
Air Coil Number of rows	3	3	3	3	3	3	3	3		3	3	3	3		
Filter Standard - 1" [25mm] MERV 4 Throw-away, in [mm]	11 x 25 [279 x 635]	11 x 25 [279 x 635]	11 x 25 [279 x 635]	16 x 20 [406 x 508]	16 x 20 [406 x 508]	16 x 25 [406 x 635]	16 x 25 [406 x 635]	2-18 x 14 [457 x 356]		1-18 x 18 [457 x 457]	1-18 x 14 [457 x 356]	2-18 x 20 [457 x 508]	1-20 x 22 [508 x 559]	1-20 x 20 [508 x 508]	
Filter Standard - 2" [51mm] Pleated MERV 13 Throwaway, in [mm]	11 x 25 [279 x 635]	11 x 25 [279 x 635]	11 x 25 [279 x 635]	16 x 20 [406 x 508]	16 x 20 [406 x 508]	16 x 25 [406 x 635]	16 x 25 [406 x 635]	18 x 29 [457 x 737]	18 x 32 [457 x 813]	18 x 32 [457 x 813]	20 x 37 [508 x 940]	1-20 x 22 [508 x 559]	1-20 x 20 [508 x 508]		

\* Not available at the time of publishing release

## Electrical Availability

### PSC

Voltage	Single Speed Models												
	006	009	012	015	018	024	030	036	041	042	048	060	070
115/60/1	•	•	•										
208-230/60/1	•	•	•	•	•	•	•	•	•	•	•	•	•
265/60/1	•	•	•	•	•	•	•	•					
208-230/60/3						•	•	•	•	•	•	•	•
460/60/3						•	•	•	•	•	•	•	•
575/60/3									•	•	•	•	•

10/15/15

### Variable Speed ECM

Voltage	Single Speed Models												
	006	009	012	015	018	024	030	036	041	042	048	060	070
208-230/60/1				•	•	•	•	•	•	•	•	•	•
265/60/1				•	•	•	•	•					
208-230/60/3						•	•	•	•	•	•	•	•
460/60/3						•	•	•	•	•	•	•	•
575/60/3													

10/15/15

### 5 Speed ECM

Voltage	Single Speed Models												
	006	009	012	015	018	024	030	036	041	042	048	060	070
208-230/60/1				•	•	•	•	•	•	•	•	•	•
265/60/1				•	•	•	•	•					
208-230/60/3						•	•	•	•	•	•	•	•
460/60/3						•	•	•	•	•	•	•	•
575/60/3													

10/15/15



## Electrical Data

### PSC Motor

Model	Rated Voltage	Voltage Min/Max	Compressor			Blower Motor FLA	Total Unit FLA	Min Circ Amp	Max Fuse/HACR Breaker
			MCC	RLA	LRA				
006	115/60/1	104/127	9.5	6.1	29.0	1.5	7.6	9.1	15
	208-230/60/1	187/253	4.7	3.0	15.0	0.6	3.6	4.4	10/15
	265/60/1	238/292	4.2	2.7	11.0	0.6	3.3	4.0	10/15
009	115/60/1	104/127	12.5	8.0	50.0	1.5	9.5	11.5	15
	208-230/60/1	187/253	6.4	4.1	21.0	0.6	4.7	5.7	10/15
	265/60/1	238/292	6.7	4.3	22.0	0.6	4.9	6.0	10/15
012	115/60/1	104/127	14.8	9.5	50.0	1.5	11	13.4	20
	208-230/60/1	187/253	7.7	4.9	25.0	0.6	5.5	6.7	10/15
	265/60/1	238/292	7.0	4.5	22.0	0.6	5.1	6.2	10/15
015	208-230/60/1	187/253	9.2	5.9	29.0	1.1	7.8	9.5	15
	265/60/1	238/292	7.8	5.0	28.0	1.0	6.6	8.0	10/15
018	208-230/60/1	187/253	10.4	6.7	33.5	1.1	7.8	9.5	15
	265/60/1	238/292	8.7	5.6	28.0	1.0	6.6	8.0	10/15
024	208-230/60/1	187/253	21.0	13.5	58.3	1.2	14.7	18.1	30
	265/60/1	238/292	14.0	9.0	54.0	1.1	10.1	12.4	20
	208-230/60/3	187/253	11.0	7.1	55.4	1.2	8.3	10.1	15
	460/60/3	414/506	5.5	3.5	28.0	0.6	4.1	5.0	10/15
030	208-230/60/1	187/253	22.0	14.1	73.0	1.5	15.6	19.1	30
	265/60/1	238/292	17.5	11.2	60.0	1.5	12.7	15.5	25
	208-230/60/3	187/253	13.9	8.9	58.0	1.5	10.4	12.6	20
	460/60/3	414/506	6.5	4.2	28.0	1.0	5.2	6.3	10/15
036	208-230/60/1	187/253	22.0	14.1	77.0	2.2	16.3	19.8	30
	265/60/1	238/292	19.0	12.2	72.0	1.1	13.3	16.4	25
	208-230/60/3	187/253	14.0	9.0	71.0	2.2	11.2	13.5	20
	460/60/3	414/506	8.8	5.6	38.0	1.1	6.7	8.1	10/15
041	208-230/60/1	187/253	28.0	17.9	112	3.5	21.4	25.9	40
	208-230/60/3	187/253	20.6	13.2	88.0	3.5	16.7	20.0	30
	460/60/3	414/506	9.3	6.0	44.0	1.8	7.8	9.3	15
	575/60/3	517/633	6.5	4.2	30.0	1.4	5.6	6.7	10/15
042	208-230/60/1	187/253	28.0	17.9	112	3.5	21.4	25.9	40
	208-230/60/3	187/253	20.6	13.2	88.0	3.5	16.7	20.0	30
	460/60/3	414/506	9.3	6.0	44.0	1.8	7.8	9.3	15
	575/60/3	517/633	6.5	4.2	30.0	1.4	5.6	6.7	10/15
048	208-230/60/1	187/253	34.0	21.8	117.0	3.5	25.3	30.8	50
	208-230/60/3	187/253	21.4	13.7	83.1	3.5	17.2	20.6	30
	460/60/3	414/506	9.7	6.2	41.0	1.8	8.0	9.6	15
	575/60/3	517/633	7.5	4.8	33.0	1.4	6.2	7.4	10/15
060	208-230/60/1	187/253	41.2	26.4	134.0	5.9	32.3	38.9	60
	208-230/60/3	187/253	24.9	16.0	110.0	5.9	21.9	25.9	40
	460/60/3	414/506	12.1	7.8	52.0	3.0	10.8	12.8	20
	575/60/3	517/633	8.9	5.7	38.9	1.9	7.6	9.0	10/15
070	208-230/60/1	187/253	44.2	28.3	178.0	5.9	34.2	41.3	60
	208-230/60/3	187/253	30.0	19.2	136.0	5.9	25.1	29.9	45
	460/60/3	414/506	13.6	8.7	66.1	3.0	11.7	13.9	20
	575/60/3	517/633	10.7	6.9	55.3	1.9	8.8	10.5	15

HACR circuit breaker in USA only

8/1/18

## Electrical Data cont.

### 5 Speed ECM Motor

Model	Rated Voltage	Voltage Min/ Max	Compressor			Blower Motor FLA	Total Unit FLA	Min Circ Amp	Max Fuse/ HACR Breaker
			MCC	RLA	LRA				
015	208-230/60/1	187/253	9.2	5.9	29.0	4.1	10.0	11.5	15
	265/60/1	238/292	7.8	5.0	28.0	3.6	8.6	9.8	10/15
018	208-230/60/1	187/253	10.4	6.7	33.5	4.1	10.8	12.5	15
	265/60/1	238/292	8.7	5.6	28.0	3.6	9.2	10.6	10/15
024	208-230/60/1	187/253	21.0	13.5	58.3	4.1	17.6	21.0	30
	265/60/1	238/292	14.0	9.0	54.0	3.6	12.6	14.9	20
	208-230/60/3	187/253	11.0	7.1	55.4	4.1	11.2	13.0	20
	460/60/3	414/506	5.5	3.5	28.0	2.1	5.6	6.5	10/15
030	208-230/60/1	187/253	22.0	14.1	73.0	4.1	18.2	21.7	35
	265/60/1	238/292	17.5	11.2	60.0	3.6	14.8	17.6	25
	208-230/60/3	187/253	13.9	8.9	58.0	4.1	13.0	15.2	20
	460/60/3	414/506	6.5	4.2	28.0	2.1	6.3	7.4	10/15
036	208-230/60/1	187/253	22.0	14.1	77.0	4.1	18.2	21.7	35
	265/60/1	238/292	19.0	12.2	72.0	3.6	15.8	18.9	30
	208-230/60/3	187/253	14.0	9.0	71.0	4.1	13.1	15.4	20
	460/60/3	414/506	8.8	5.6	38.0	2.1	7.7	9.1	10/15
041	208-230/60/1	187/253	28.0	17.9	112.0	4.1	22.0	26.5	40
	208-230/60/3	187/253	20.6	13.2	88.0	4.1	17.3	20.6	30
	460/60/3	414/506	9.3	6.0	44.0	2.1	8.1	9.6	15
042	208-230/60/1	187/253	28.0	17.9	112.0	7.6	25.5	30.0	45
	208-230/60/3	187/253	20.6	13.2	88.0	7.6	20.8	24.1	35
	460/60/3	414/506	9.3	6.0	44.0	4.0	10.0	11.5	15
048	208-230/60/1	187/253	34.0	21.8	117.0	7.6	29.4	34.9	55
	208-230/60/3	187/253	21.4	13.7	83.1	7.6	21.3	24.7	35
	460/60/3	414/506	9.7	6.2	41.0	4.0	10.2	11.8	15
060	208-230/60/1	187/253	41.2	26.4	134.0	7.6	34.0	40.6	60
	208-230/60/3	187/253	24.9	16.0	110.0	7.6	23.6	27.6	40
	460/60/3	414/506	12.1	7.8	52.0	4.0	11.8	13.8	20
070	208-230/60/1	187/253	44.2	28.3	178.0	7.6	35.9	43.0	70
	208-230/60/3	187/253	30.0	19.2	136.0	7.6	26.8	31.6	50
	460/60/3	414/506	13.6	8.7	66.1	4.0	12.7	14.9	20

HACR circuit breaker in USA only

8/1/18

## Electrical Data cont.

### Variable Speed ECM Motor

Model	Rated Voltage	Voltage Min/Max	Compressor			Blower Motor FLA	Total Unit FLA	Min Circ Amp	Max Fuse/HACR Breaker
			MCC	RLA	LRA				
006	115/60/1	104/127	9.5	6.1	29.0	1.8	7.9	9.4	15
	208-230/60/1	187/253	4.7	3.0	15.0	0.9	3.9	4.7	10/15
009	115/60/1	104/127	12.5	8.0	50.0	1.8	9.8	11.8	20
	208-230/60/1	187/253	6.4	4.1	21.0	0.9	5.0	6.1	10/15
012	115/60/1	104/127	14.8	9.5	50.0	1.8	11.25	13.6	20
	208-230/60/1	187/253	7.7	4.9	25.0	0.9	5.8	7.1	10/15
015	208-230/60/1	187/253	9.2	5.9	29.0	4.0	9.9	11.4	15
	265/60/1	238/292	7.8	5.0	28.0	4.1	9.1	10.3	15
018	208-230/60/1	187/253	10.4	6.7	33.5	4.0	10.7	12.4	15
	265/60/1	238/292	8.7	5.6	28.0	4.1	9.7	11.1	15
024	208-230/60/1	187/253	21.0	13.5	58.3	4.0	17.5	20.9	30
	265/60/1	238/292	14.0	9.0	54.0	4.1	13.1	15.4	20
	208-230/60/3	187/253	11.0	7.1	55.4	4.0	11.1	12.9	15
	460/60/3	414/506	5.5	3.5	28.0	4.1	7.6	8.5	10/15
030	208-230/60/1	187/253	22.0	14.1	73.0	4.0	18.1	21.6	35
	265/60/1	238/292	17.5	11.2	60.0	4.1	15.3	18.1	25
	208-230/60/3	187/253	13.9	8.9	58.0	4.0	12.9	15.1	20
	460/60/3	414/506	6.5	4.2	28.0	4.1	8.3	9.4	10/15
036	208-230/60/1	187/253	22.0	14.1	77.0	4.0	18.1	21.6	35
	265/60/1	238/292	19.0	12.2	72.0	4.1	16.3	19.4	30
	208-230/60/3	187/253	14.0	9.0	71.0	4.0	13.0	15.3	20
	460/60/3	414/506	8.8	5.6	38.0	4.1	9.7	11.1	15
041	208-230/60/1	187/253	28.0	17.9	112.0	4.0	21.9	26.4	40
	208-230/60/3	187/253	20.6	13.2	88.0	4.0	17.2	20.5	30
	460/60/3	414/506	9.3	6.0	44.0	4.1	10.1	11.6	15
042	208-230/60/1	187/253	28.0	17.9	112.0	4.0	21.9	26.4	40
	208-230/60/3	187/253	20.6	13.2	88.0	4.0	17.2	20.5	30
	460/60/3	414/506	9.3	6.0	44.0	4.1	10.1	11.6	15
048	208-230/60/1	187/253	34.0	21.8	117.0	4.0	25.8	31.3	50
	208-230/60/3	187/253	21.4	13.7	83.1	4.0	17.7	21.1	30
	460/60/3	414/506	9.7	6.2	41.0	4.1	10.3	11.9	15
060	208-230/60/1	187/253	41.2	26.4	134.0	7.0	33.4	40.0	60
	208-230/60/3	187/253	24.9	16.0	110.0	7.0	23.0	27.0	40
	460/60/3	414/506	12.1	7.8	52.0	6.9	14.7	16.7	20
070	208-230/60/1	187/253	44.2	28.3	178.0	7.0	35.3	42.4	70
	208-230/60/3	187/253	30.0	19.2	136.0	7.0	26.2	31.0	50
	460/60/3	414/506	13.6	8.7	66.1	6.9	15.6	17.8	25

HACR circuit breaker in USA only

8/1/18



**Caution:** When installing a unit with a Variable Speed ECM blower motor in 460/60/3 voltage, a neutral wire is required to allow proper unit operation.

# Blower Performance Data

## Standard PSC Motor

Model	Blower	Blower	Motor	Airflow (cfm) at External Static Pressure (in. wg)															
	Spd	Size	HP	0	0.05	0.10	0.15	0.20	0.25	0.30	0.35	0.40	0.45	0.50	0.60	0.70	0.80	0.90	1.00
006	H	6 x 8	1/10	435	425	415	405	390	365	340	325	305	290	275	245	-	-	-	-
	MH			400	390	380	370	355	335	310	295	280	265	255	210	195	-	-	-
	ML*			365	355	345	335	315	300	280	270	255	240	230	195	-	-	-	-
	L			320	305	295	280	260	250	235	225	210	195	180	150	135	-	-	-
009	H	6 x 8	1/10	435	423	415	405	390	370	340	325	305	290	275	245	-	-	-	-
	MH			400	388	380	370	355	335	310	295	280	265	255	210	195	-	-	-
	ML*			365	353	345	335	315	300	280	270	255	240	230	195	-	-	-	-
	L			320	305	295	280	260	250	235	225	210	195	180	150	135	-	-	-
012	H	6 x 8	1/10	435	423	415	405	390	370	340	325	305	290	275	245	-	-	-	-
	MH			400	388	380	370	355	335	310	295	280	265	255	210	195	-	-	-
	ML*			365	353	345	335	315	300	280	270	255	240	230	195	-	-	-	-
	L			320	305	295	280	260	250	235	225	210	195	180	150	135	-	-	-
015	H	9 x 7	1/6	795	775	755	735	715	690	670	600	530	490	455	395	-	-	-	-
	M			725	710	695	675	660	640	620	560	495	465	435	375	-	-	-	-
	L			620	610	600	590	575	550	525	490	455	395	340	290	-	-	-	-
018	H	9 x 7	1/6	795	775	755	735	715	690	670	600	530	490	455	395	-	-	-	-
	M			725	710	695	675	660	640	620	560	495	465	435	375	-	-	-	-
	L			620	610	600	590	575	550	525	490	455	395	340	290	-	-	-	-
024	H	9 x 7	1/5	1035	1015	995	970	950	925	900	865	835	795	760	685	560	-	-	-
	M			880	860	845	820	805	785	765	740	720	690	665	590	530	-	-	-
	L			810	790	775	755	740	725	705	675	650	620	595	510	-	-	-	-
030	H	9 x 7	1/3	1170	1145	1130	1110	1080	1050	1030	995	965	925	890	815	700	-	-	-
	M			1040	1030	1020	1005	990	965	945	915	890	860	830	760	650	-	-	-
	L			825	820	815	810	805	795	790	775	765	735	705	655	-	-	-	-
036	H	9 x 7	1/2	1320	1295	1275	1240	1210	1185	1155	1120	1085	1045	1005	915	805	655	-	-
	M			1180	1155	1140	1125	1100	1075	1055	1020	990	955	920	840	725	590	-	-
	L			1045	1035	1025	1015	1005	985	970	945	920	890	865	795	690	-	-	-
041	H	9 x 7	1/3	1140	1115	1090	1060	1030	1000	975	940	905	865	830	750	353	-	-	-
	M			1025	1000	980	955	935	910	885	850	820	780	745	670	475	-	-	-
	L			935	920	905	885	865	845	825	795	770	740	710	565	-	-	-	-
042	H	10x10	1/2	1530	1500	1475	1445	1425	1380	1340	1290	1240	1185	1130	810	715	630	-	-
	M			1435	1415	1395	1370	1350	1325	1300	1265	1235	1180	1130	1040	755	640	-	-
	L			1160	1140	1130	1120	1100	1070	1050	1020	990	950	910	831	632	590	-	-
048	H	10 x 10	1/2	1845	1810	1775	1740	1705	1660	1615	1560	1510	1455	1405	1275	1080	-	-	-
	M			1655	1620	1585	1555	1535	1500	1465	1415	1370	1330	1290	1170	970	-	-	-
	L			1325	1315	1310	1285	1265	1245	1220	1180	1140	1115	1090	990	-	-	-	-
060	H	11 x 10	1	2345	2320	2305	2285	2250	2205	2180	2135	2090	2060	2030	1945	1850	1740	1600	1465
	M			2195	2170	2150	2125	2105	2075	2045	2005	1970	1940	1915	1845	1770	1630	1500	-
	L			2045	2030	2020	1995	1980	1950	1925	1890	1855	1825	1800	1750	1640	1535	1395	-
070	H	11 x 10	1	2505	2475	2450	2410	2385	2365	2340	2305	2275	2250	2230	2170	2070	1975	1880	1765
	M			2290	2265	2250	2230	2200	2170	2150	2135	2125	2105	2085	2015	1950	1865	1785	1680
	L			2115	2100	2085	2060	2040	2020	2005	1990	1975	1950	1930	1875	1805	1720	1655	1510

Factory settings are in Bold

10/15/15

Airflow values are with dry coil and standard filter

For wet coil performance first calculate the face velocity of the air coil (Face Velocity [fpm] = Airflow [cfm] / Face Area [sq ft]).

Then for velocities of 200 fpm reduce the static capability by 0.03 in. wg, 300 fpm by 0.08 in. wg, 400 fpm by 0.12 in. wg, and 500 fpm by 0.16 in. wg.

\* Setting for 265V operation.



## Blower Performance Data cont.

### Variable Speed ECM Motor

Model	Max ESP	Blower Size	Motor hp	Air Flow Dip Switch Settings											
				1	2	3	4	5	6	7	8	9	10	11	12
015	0.50	9 x 7	1/2	300	400 L	<b>500</b>	<b>600</b> M	<b>700</b> H	<b>800</b>						
018	0.50	9 x 7	1/2	300	400 L	<b>500</b>	<b>600</b> M	<b>700</b> H	<b>800</b>						
024	0.50	9 x 7	1/2		400 L	500	600 M	<b>700</b> H	<b>800</b> H	<b>900</b>	<b>1000</b>	<b>1100</b>			
030	0.50	9 x 7	1/2		400	500 L	600	<b>700</b> M	<b>800</b>	<b>900</b>	<b>1000</b> H	<b>1100</b>			
036	0.50	9 x 7	1/2		400	500	600 L	700	<b>800</b>	<b>900</b> M	<b>1000</b>	<b>1100</b> H	<b>1200</b>		
041	0.50	9 x 7	1/2		400	500	600	700 L	875	<b>1050</b> M	<b>1150</b>	<b>1250</b>	<b>1325</b> H	<b>1375</b>	
042	0.50	11 x 10	1/2	500	600	700 L	875	<b>1050</b>	<b>1150</b> M	<b>1250</b>	<b>1325</b>	<b>1375</b> H	<b>1475</b>	<b>1550</b>	
048	0.50	11 x 10	1/2	500	600	700	875 L	1050	1150	<b>1250</b>	<b>1325</b> M	<b>1375</b>	<b>1475</b>	<b>1550</b> H	<b>1600</b>
060	0.75	11 x 10	1	600	800	1000 L	1300	<b>1500</b> M	<b>1750</b>	<b>1950</b> H	<b>2100</b>	<b>2200</b>	<b>2300</b>		
070	0.75	11 x 10	1	600	800	1000 L	1300	<b>1500</b> M	<b>1750</b>	<b>1950</b>	<b>2100</b> H	<b>2200</b>	<b>2300</b>		

Factory settings are at recommended L-M-H DIP switch locations

10/15/15

CFM is controlled within ±5% up to the maximum ESP

M-H settings MUST be located within boldface CFM range

Max ESP includes allowance for wet coil and standard filter

Lowest and Highest DIP switch settings are assumed to be L and H respectively

## Blower Performance Data cont.

### Setting Blower Speed - Variable Speed ECM

The ABC board's Yellow Config LED will flash the current variable speed ECM blower speed selections for low, med, and high continuously with a short pause in between. The speeds can also be confirmed with the AID Tool under the Setup/ECM Setup screen. The variable speed ECM blower motor speeds can be field adjusted with or without using an AID Tool.

### Variable Speed ECM Setup without an AID Tool

The blower speeds for Low (G only), Med (Y1), and High (Y2/Aux) can be adjusted directly at the Aurora ABC board which utilizes the push button (SW1) on the ABC board. This procedure is outlined in the Variable Speed ECM Configuration Mode portion of the Aurora 'Base' Control System section.

### Variable Speed ECM Setup with an AID Tool

A much easier method utilizes the AID Tool to change the airflow using the procedure below. First navigate to the Setup screen and then select ECM Setup. This screen displays the current variable speed ECM settings. It allows the technician to enter the setup screens to change the variable speed ECM settings. Change the highlighted item using the ◀ and ▶ buttons and then press the ◻ button to select the item.

### Variable Speed ECM Setup with an AID Tool cont.

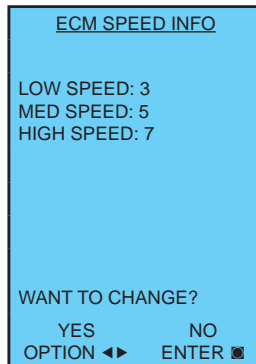

Selecting YES will enter variable speed ECM speed setup, while selecting NO will return to the previous screen.

**Variable Speed ECM Speed Setup** - These screens allow the technician to select the low, medium, and high blower speed for the variable speed ECM blower motor. Change the highlighted item using the ▲ and ▼ buttons. Press the ◻ button to select the speed.

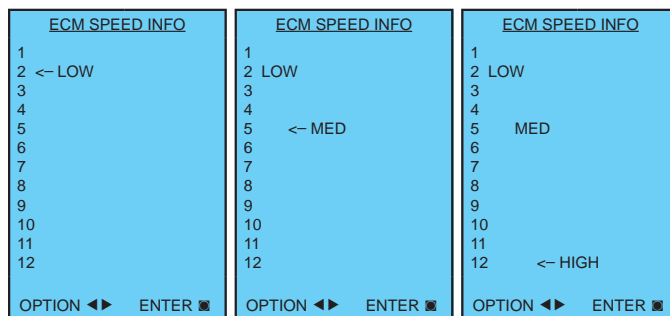

After the high speed setting is selected the AID Tool will automatically transfer back to the ECM Setup screen.

## Selection Example

To achieve optimal performance, proper selection of each heat pump is essential. A building load program should be used to determine the heating and cooling load of each zone. A computer software selection program can then be used to develop an accurate and complete heat pump schedule. Software can be obtained from your local representative.

While a computer software program is the easiest and most accurate method to size and select equipment, however, selection can still be accomplished manually using this manual and the following selection procedure. Sizing so that the actual sensible capacity of the equipment will satisfy the sensible capacity of the zone is the recommended method for best results.

### Boiler/Tower Application

Typical boiler/tower application will result in entering water temperatures of 60-90°F with 70°F for heating and 90°F for cooling. Water to refrigerant insulation option would not be required. Flow rates are 2.5 to 3 gpm per ton with 2.5 gpm per ton often representing an economical design point.

### Geothermal Application

Typical geothermal application can result in a wide entering water temperature range of 30-100°F. Typically minimum heating entering water temperatures can range from 30 to 50°F depending upon loop type and geographical location. Cooling performance should be calculated using a maximum loop temperature of 100°F in most loop applications. Water flow is typically 2.5 to 3 gpm per ton with 3 gpm per ton recommended with the more extreme loop temperatures. PLEASE NOTE THAT WATER COIL INSULATION OPTION SHOULD BE SELECTED WHEN ENTERING WATER TEMPERATURES ARE EXPECTED TO BE BELOW 45-50°F.

### Geothermal Selection Example

Step 1: Determine the actual heating and cooling loads at the desired dry bulb and wet bulb conditions.

Step 2: Obtain the following design parameters: Entering water temperature, water flow rate in gpm, airflow in cfm, water flow pressure drop and design wet and dry bulb temperatures. Airflow, cfm, should be between 300 and 450 cfm per ton. Unit water pressure drop should be kept as close as possible to each other to make water balancing easier. Go to the appropriate tables and find the proper indicated water flow and water temperature.

Step 3: Select a unit based on total and sensible cooling conditions. Select a unit which is closest to, but no larger than, the actual cooling load.

Step 4: Enter tables at the design water flow and water temperature. Read the total and sensible cooling capacities (**NOTE:** interpolation is permissible, extrapolation is not).

Step 5: Read the heating capacity. If it exceeds the design criteria it is acceptable. It is quite normal for water source heat pumps to be selected on cooling capacity only since the heating output is usually greater than the cooling capacity.

Step 6: Determine the correction factors associated with the variable factors of dry bulb and wet bulb.  
 Corrected Total Cooling = tabulated total cooling x wet bulb correction.  
 Corrected Sensible Cooling = tabulated sensible cooling x wet/dry bulb correction.

Step 7: Compare the corrected capacities to the load requirements. Normally if the capacities are within 10% of the loads, the equipment is acceptable. It is better to undersize than oversize, as undersizing improves humidity control, reduces sound levels and extends the life of the equipment.

Step 8: When complete, calculate water temperature rise and assess the selection. If the units selected are not within 10% of the load calculations, then review what effect changing the gpm, water temperature and/or airflow and air temperature would have on the corrected capacities. If the desired capacity cannot be achieved, select the next larger or smaller unit and repeat the procedure. Remember, when in doubt, undersize slightly for best performance.

### Example Equipment Selection - Cooling

#### 1. Load Determination:

Assume we have determined that the appropriate cooling load at the desired dry bulb 80°F and wet bulb 65°F conditions is as follows:

Total Cooling..... 51,500 Btu/h  
 Sensible Cooling..... 34,300 Btu/h  
 Entering Air Temp ..... 75°F Dry Bulb / 65°F Wet Bulb

#### 2. Design Conditions:

Similarly, we have also obtained the following design parameters:

Entering Water Temp ..... 90°F  
 Water Flow (Based upon 10°F rise in temp.) 15.0 gpm  
 Airflow Required ..... 1,750 cfm @ 0.2 in. wg.



## Selection Example cont.

3, 4 & 5. HP Selection:

After making our preliminary selection (UB\*060 variable speed ECM), we enter the tables at design water flow and water temperature and read

Total Cooling, Sens. Cooling and Heat of Rej. capacities:

Total Cooling.....54,100 Btu/h  
 Sensible Cooling.....40,500 Btu/h  
 Heat of Rejection.....68,800 Btu/h

$$HR = 500 \times \text{gpm} \times (T_{in} - T_{out})$$

$$\frac{HR}{500 \times \text{gpm}} = (T_{in} - T_{out}) \text{ or } \Delta T \text{ Rise}$$

$$\frac{65,402}{500 \times 15} = 8.72 \text{ } ^\circ\text{F Rise}$$

6 & 7. Entering Air and Airflow Corrections:

Next, we determine our correction factors. (Refer to Correction Factor Tables - Airflow and Entering Air correction tables — using 1750 cfm. or 1,750÷2,000 nom. = 87.5%).

Corrected Total Cooling = 54,100 x 0.982 x 0.967 = 51,373  
 Corrected Sens Cooling = 40,500 x 0.929 x 0.881 = 33,147  
 Corrected Heat of Reject = 68,800 x 0.978 x 0.972 = 65,402

8. Water Temperature Rise Calculation & Assessment:  
**NOTE:** 500 = parameters for water & 485 = parameters for antifreeze solutions to 30% weight.

When we compare the Corrected Total Cooling and Corrected Sensible Cooling figures with our load requirements stated in Step 1, we discover that our selection is within +10% of our sensible load requirement. Further more, we see that our Corrected Total Cooling figure is within 1,000 Btu/h of the actual indicated load.

## Antifreeze Corrections

Catalog performance can be corrected for antifreeze use. Please use the following table and note the example given.

Antifreeze Type	Antifreeze % by wt	Cooling Capacity	Heating Capacity	Pressure Drop
EWT - degF [DegC]		90 [32.2]	30 [-1.1]	30 [-1.1]
Water	0	1.000	1.000	1.000
Ethylene Glycol	10	0.991	0.973	1.075
	20	0.979	0.943	1.163
	30	0.965	0.917	1.225
	40	0.955	0.890	1.324
	50	0.943	0.865	1.419
Propylene Glycol	10	0.981	0.958	1.130
	20	0.969	0.913	1.270
	30	0.950	0.854	1.433
	40	0.937	0.813	1.614
	50	0.922	0.770	1.816
Ethanol	10	0.991	0.927	1.242
	20	0.972	0.887	1.343
	30	0.947	0.856	1.383
	40	0.930	0.815	1.523
	50	0.911	0.779	1.639
Methanol	10	0.986	0.957	1.127
	20	0.970	0.924	1.197
	30	0.951	0.895	1.235
	40	0.936	0.863	1.323
	50	0.920	0.833	1.399

**Warning:** Gray area represents antifreeze concentrations greater than 35% by weight and should be avoided due to the extreme performance penalty they represent.

## Antifreeze Correction Example

Antifreeze solution is Propylene Glycol 20% by weight. Determine the corrected heating and cooling performance at 30°F and 90°F respectively as well as pressure drop at 30°F for a Model 024-PSC.

The corrected cooling capacity at 90°F would be: 22,600 Btu/h x 0.969 = 21,899 Btu/h

The corrected heating capacity at 30°F would be: 16,800 Btu/h x 0.913 = 15,338 Btu/h

The corrected pressure drop at 30°F and 6 gpm would be: 20.8 ft. hd x 1.270 = 26.42 ft. hd.

## Legend and Notes

### ABBREVIATIONS AND DEFINITIONS:

cfm = airflow, cubic feet/minute	HE = total heat of extraction, MBtu/h
EWT = entering water temperature, Fahrenheit	HWC = hot water generator capacity, MBtu/h
gpm = water flow in gallons/minute	EER = Energy Efficient Ratio = BTU output/Watt input
WPD = water pressure drop, psi and feet of water	COP = Coefficient of Performance = Btu output/Btu input
EAT = entering air temperature, Fahrenheit (dry bulb/wet bulb)	LWT = leaving water temperature, °F
HC = air heating capacity, MBtu/h	LAT = leaving air temperature, °F
TC = total cooling capacity, MBtu/h	TH = total heating capacity, MBtu/h
SC = sensible cooling capacity, MBtu/h	LC = latent cooling capacity, MBtu/h
kW = total power unit input, kilowatts	S/T = sensible to total cooling ratio
HR = total heat of rejection, MBtu/h	

### Notes (Refer to Performance Data tables)

- Performance ratings are based on 80°F DB / 67°F WB EAT for cooling and 70°F DB EAT for heating.
- Three flow rates are shown for each unit. The lowest flow rate shown is used for geothermal open loop/well water systems with a minimum of 50°F EWT. The middle flow rate shown is the minimum geothermal closed loop flow rate. The highest flow rate shown is optimum for geothermal closed loop systems and the suggested flow rate for boiler/tower applications.
- Entering water temperatures below 40°F assumes 15% antifreeze solution.
- For non-standard EAT conditions, apply the appropriate correction factors on (Refer to Correction Factor Tables).
- Interpolation between EWT, gpm, and cfm data is permissible.

## Reference Calculations

Heating Calculations:	Cooling Calculations:
$LWT = EWT - \frac{HE}{gpm \times 500}$	$LWT = EWT + \frac{HR}{gpm \times 500}$
$LAT = EAT + \frac{HC}{cfm \times 1.08}$	$LAT(DB) = EAT(DB) - \frac{SC}{cfm \times 1.08}$
$TH = HC + HWC$	$LC = TC - SC$
	$S/T = \frac{SC}{TC}$

## Operating Limits

Operating Limits	Cooling		Heating	
	(°F)	(°C)	(°F)	(°C)
<b>Air Limits</b>				
Min. Ambient Air	45	7.2	45	7.2
Rated Ambient Air	80	26.7	70	21.1
Max. Ambient Air	100	37.8	85	29.4
Min. Entering Air	50	10.0	40	4.4
Rated Entering Air db/wb	80.6/66.2	27/19	68	20.0
Max. Entering Air db/wb	110/83	43/28.3	80	26.7
<b>Water Limits</b>				
Min. Entering Water	30	-1.1	20	-6.7
Normal Entering Water	50-110	10-43.3	30-70	-1.1
Max. Entering Water	120	48.9	90	32.2

**NOTE:** Minimum/maximum limits are only for start-up conditions, and are meant for bringing the space up to occupancy temperature. Units are not designed to operate at the minimum/maximum conditions on a regular basis. The operating limits are dependent upon three primary factors: 1) water temperature, 2) return air temperature, and 3) ambient temperature. When any of the factors are at the minimum or maximum levels, the other two factors must be at the normal level for proper and reliable unit operation.

## Cooling Capacity Corrections

Entering Air WB °F	Total Clg Cap	Sensible Cooling Capacity Multipliers - Entering DB °F										Power Input	Heat of Rejection
		60	65	70	75	80	80.6	85	90	95	100		
55	0.898	0.723	0.866	1.048	1.185	*	*	*	*	*	*	0.985	0.913
60	0.912		0.632	0.880	1.078	1.244	1.260	*	*	*	*	0.994	0.927
65	0.967			0.694	0.881	1.079	1.085	1.270	*	*	*	0.997	0.972
66.2	0.983			0.655	0.842	1.040	1.060	1.232	*	*	*	0.999	0.986
<b>67</b>	<b>1.000</b>			0.616	0.806	<b>1.000</b>	1.023	1.193	1.330	*	*	<b>1.000</b>	<b>1.000</b>
70	1.053				0.693	0.879	0.900	1.075	1.250	1.404	*	1.003	1.044
75	1.168					0.687	0.715	0.875	1.040	1.261	1.476	1.007	1.141

**NOTE:** \* Sensible capacity equals total capacity at conditions shown.

11/10/09

## Heating Corrections

Ent Air DB °F	Htg Cap	Power	Heat of Ext
45	1.062	0.739	1.158
50	1.050	0.790	1.130
55	1.037	0.842	1.096
60	1.025	0.893	1.064
65	1.012	0.945	1.030
68	1.005	0.976	1.012
<b>70</b>	<b>1.000</b>	<b>1.000</b>	<b>1.000</b>
75	0.987	1.048	0.970
80	0.975	1.099	0.930

11/10/09

## Airflow Corrections

Airflow		Cooling				Heating		
cfm Per Ton of Clg	% of Nominal	Total Cap	Sens Cap	Power	Heat of Rej	Htg Cap	Power	Heat of Ext
240	60	0.922	0.786	0.910	0.920	0.943	1.150	0.893
275	69	0.944	0.827	0.924	0.940	0.958	1.105	0.922
300	75	0.959	0.860	0.937	0.955	0.968	1.078	0.942
325	81	0.971	0.894	0.950	0.967	0.977	1.053	0.959
350	88	0.982	0.929	0.964	0.978	0.985	1.031	0.973
375	94	0.992	0.965	0.982	0.990	0.993	1.014	0.988
<b>400</b>	<b>100</b>	<b>1.000</b>	<b>1.000</b>	<b>1.000</b>	<b>1.000</b>	<b>1.000</b>	<b>1.000</b>	<b>1.000</b>
425	106	1.007	1.034	1.020	1.010	1.007	0.990	1.011
450	113	1.012	1.065	1.042	1.018	1.013	0.983	1.020
475	119	1.017	1.093	1.066	1.026	1.018	0.980	1.028
500	125	1.019	1.117	1.092	1.033	1.023	0.978	1.034
520	130	1.020	1.132	1.113	1.038	1.026	0.975	1.038

11/10/09

# Pressure Drop

Model	GPM	Pressure Drop (psi)				
		30°F	50°F	70°F	90°F	110°F
006	1.0	1.2	1.2	1.1	1.0	1.0
	1.5	2.2	2.0	1.9	1.8	1.7
	2.0	3.3	3.1	2.9	2.7	2.5
	2.5	4.1	3.8	3.4	3.1	2.9
009	1.5	1.9	1.7	1.5	1.3	1.1
	2.0	3.0	2.8	2.6	2.4	2.2
	3.0	6.3	6.3	6.1	5.9	5.7
	4.0	8.1	7.9	7.4	6.8	6.1
012	1.5	1.1	1.1	1.0	0.9	0.9
	2.5	2.4	2.3	2.2	2.0	1.9
	3.5	4.2	4.0	3.7	3.4	3.2
	4.5	6.1	5.9	5.2	4.7	4.1
015	2.0	1.8	1.7	1.6	1.4	1.2
	3.0	3.3	3.1	2.9	2.6	2.3
	4.0	5.0	4.9	4.8	4.7	4.6
	5.0	7.1	6.7	5.9	5.4	5.1
018	3.0	3.3	3.2	3.0	2.8	2.6
	4.0	4.7	4.2	3.9	3.6	3.1
	5.0	6.2	5.2	4.7	4.1	3.5
	6.0	7.7	6.2	5.4	4.6	3.8
024	3.0	3.2	3.1	2.9	2.7	2.5
	4.5	6.1	5.5	4.9	4.5	4.2
	6.0	9.0	7.9	6.9	6.3	5.8
	8.0	12.9	10.9	9.5	8.8	7.9
030	4.0	2.4	2.3	2.2	2.0	1.8
	6.0	5.1	4.9	4.7	4.5	4.3
	8.0	7.8	7.5	7.1	6.9	6.7
	10.0	10.5	10.1	9.6	9.3	8.9
036	5.0	2.0	1.9	1.7	1.5	1.4
	7.0	3.6	3.5	3.3	3.1	2.9
	9.0	5.2	5.1	4.8	4.6	4.4
	12.0	7.5	7.4	7.1	6.9	6.7
041	5.0	1.5	1.2	0.9	0.5	0.4
	8.0	3.4	3.1	2.8	2.5	2.1
	11.0	7.9	7.5	7.2	6.9	6.6
	14.0	9.1	8.8	8.5	8.2	7.9
042	5.0	2.1	2.0	1.8	1.6	1.4
	8.0	4.8	4.7	4.5	4.4	4.2
	11.0	7.5	7.4	7.0	6.6	6.1
	14.0	10.1	9.9	9.6	8.8	8.1
048	6.0	2.7	2.6	2.4	2.2	2.0
	9.0	6.0	5.9	5.4	5.2	5.1
	12.0	9.5	9.3	8.5	8.3	8.1
	16.0	14.2	13.9	12.7	12.3	12.1
060	9.0	4.5	4.4	4.2	4.0	3.8
	12.0	6.5	6.3	6.1	5.9	5.7
	15.0	8.6	8.1	7.9	7.7	7.5
	20.0	12.1	11.2	10.8	10.6	10.4
070	12.0	5.7	5.6	5.4	5.2	5.0
	15.0	8.9	8.6	8.2	7.7	6.7
	18.0	12.0	11.5	11.0	10.1	8.4
	24.0	17.4	16.9	16.5	15.1	11.8

10/15/15

Valve	GPM	Cv	Pressure Drop (psi)
Internally mounted 2-position solenoid water valves are not available on models 006-012			
1/2"	3.0	9.9	0.09
	4.0	10.1	0.16
	5.0	10.4	0.23
	6.0	10.6	0.32
1/2"	3.0	9.9	0.09
	4.0	10.1	0.16
	5.0	10.4	0.23
	6.0	10.6	0.32
3/4"	3.0	9.9	0.09
	4.5	10.2	0.19
	6.0	10.6	0.32
	8.0	11.0	0.53
3/4"	4.0	10.1	0.16
	6.0	10.6	0.32
	8.0	11.0	0.53
	10.0	11.5	0.76
3/4"	5.0	10.4	0.23
	7.0	10.8	0.42
	9.0	11.2	0.64
	12.0	11.9	1.02
N/A			
3/4"	5.0	10.4	0.23
	8.0	11.0	0.53
	11.0	11.7	0.89
	14.0	12.3	1.29
3/4"	6.0	10.6	0.32
	9.0	11.2	0.64
	12.0	11.9	1.02
	16.0	12.8	1.57
1"	9.0	16.8	0.29
	12.0	17.4	0.47
	15.0	18.1	0.69
	20.0	19.2	1.09
1"	12.0	17.4	0.47
	15.0	18.1	0.69
	18.0	18.7	0.92
	24.0	20.1	1.43

10/15/15

## ZB006 - Performance Data

### Single Speed with PSC (250 cfm)

EWT °F	WATER FLOW GPM	WPD		HEATING - EAT 70 °F					COOLING - EAT 80/67 °F					
		PSI	FT	HC MBtu/h	Power kW	HE MBtu/h	LAT °F	COP	TC MBtu/h	SC MBtu/h	S/T Ratio	Power kW	HR MBtu/h	EER
20	1.0	1.3	3.0	Operation not recommended					Operation not recommended					
	1.5	2.2	5.1	Operation not recommended					Operation not recommended					
	2.0	3.4	7.9	4.3	0.54	2.4	83.8	2.31	Operation not recommended					
30	1.0	1.2	2.8	Operation not recommended					Operation not recommended					
	1.5	2.2	5.1	4.9	0.55	3.0	86.0	2.60	8.5	5.2	0.62	0.36	9.7	23.5
	2.0	3.3	7.6	5.0	0.55	3.1	86.5	2.65	8.6	5.3	0.62	0.34	9.8	25.1
40	1.0	1.2	2.8	Operation not recommended					Operation not recommended					
	1.5	2.1	4.9	5.8	0.57	3.8	89.4	2.98	8.6	5.3	0.62	0.39	9.9	21.7
	2.0	3.2	7.4	6.0	0.58	4.0	90.1	3.03	8.7	5.4	0.62	0.37	9.9	23.1
50	1.0	1.2	2.8	6.4	0.58	4.4	91.8	3.23	8.6	5.3	0.62	0.46	10.1	18.5
	1.5	2.0	4.6	6.7	0.59	4.7	92.9	3.33	8.6	5.4	0.63	0.43	10.1	20.2
	2.0	3.1	7.2	6.9	0.60	4.9	93.6	3.39	8.7	5.5	0.63	0.41	10.1	21.5
60	1.0	1.1	2.5	7.1	0.60	5.1	94.3	3.48	7.9	5.1	0.64	0.49	9.6	16.2
	1.5	2.0	4.6	7.4	0.61	5.3	95.5	3.58	8.0	5.1	0.64	0.46	9.6	17.2
	2.0	3.0	6.9	7.6	0.61	5.5	96.3	3.64	8.2	5.3	0.64	0.45	9.7	18.1
70	1.0	1.1	2.5	7.8	0.61	5.7	96.7	3.71	7.3	4.8	0.66	0.54	9.2	13.7
	1.5	1.9	4.3	8.1	0.62	6.0	98.0	3.82	7.4	4.9	0.66	0.51	9.2	14.6
	2.0	2.9	6.7	8.4	0.63	6.2	99.0	3.89	7.6	5.0	0.66	0.49	9.3	15.4
80	1.0	1.1	2.5	8.6	0.63	6.4	99.7	4.00	7.0	4.7	0.67	0.59	9.0	11.8
	1.5	1.8	4.2	8.9	0.64	6.8	101.1	4.11	7.1	4.8	0.67	0.56	9.0	12.6
	2.0	2.8	6.5	9.2	0.64	7.0	102.1	4.19	7.3	4.9	0.67	0.55	9.1	13.3
90	1.0	1.0	2.3	9.3	0.64	7.2	102.6	4.27	6.7	4.5	0.68	0.65	8.9	10.3
	1.5	1.8	4.2	9.8	0.65	7.5	104.2	4.40	6.8	4.6	0.68	0.62	8.9	10.9
	2.0	2.7	6.2	10.1	0.66	7.8	105.3	4.48	6.9	4.7	0.68	0.60	8.9	11.5
100	1.0	1.0	2.3	Operation not recommended					Operation not recommended					
	1.5	1.7	3.9	Operation not recommended					6.3	4.4	0.70	0.68	8.6	9.2
	2.0	2.6	6.0	Operation not recommended					6.4	4.5	0.70	0.66	8.6	9.6
110	1.0	1.0	2.3	Operation not recommended					Operation not recommended					
	1.5	1.7	3.9	Operation not recommended					5.7	4.1	0.72	0.74	8.2	7.7
	2.0	2.5	5.8	Operation not recommended					5.8	4.2	0.72	0.72	8.3	8.1
120	1.0	0.9	2.1	Operation not recommended					Operation not recommended					
	1.5	1.6	3.7	Operation not recommended					5.1	3.9	0.77	0.80	7.9	6.4
	2.0	2.4	5.5	Operation not recommended					5.2	4.0	0.77	0.78	7.9	6.7

8/9/2018

## ZB009 - Performance Data

### Single Speed with PSC (350 cfm)

EWT °F	WATER FLOW GPM	WPD		HEATING - EAT 70 °F					COOLING - EAT 80/67 °F					
		PSI	FT	HC MBtu/h	Power kW	HE MBtu/h	LAT °F	COP	TC MBtu/h	SC MBtu/h	S/T Ratio	Power kW	HR MBtu/h	EER
20	1.5	2.0	4.6	Operation not recommended					Operation not recommended					
	2.0	3.1	7.2	Operation not recommended					Operation not recommended					
	3.0	6.4	14.8	6.2	0.69	3.8	84.3	2.62	Operation not recommended					
30	1.5	1.9	4.4	Operation not recommended					Operation not recommended					
	2.0	3.0	6.9	7.0	0.69	4.6	86.5	2.97	10.2	6.9	0.68	0.46	11.8	22.0
	3.0	6.3	14.6	7.2	0.70	4.8	87.0	3.02	10.3	7.0	0.68	0.44	11.8	23.4
40	1.5	1.8	4.2	Operation not recommended					Operation not recommended					
	2.0	2.9	6.7	7.9	0.71	5.5	88.9	3.28	10.1	7.2	0.71	0.49	11.8	20.7
	3.0	6.2	14.3	8.2	0.72	5.7	89.6	3.34	10.3	7.3	0.71	0.47	11.8	22.0
50	1.5	1.7	3.9	8.4	0.71	6.0	90.3	3.48	10.0	7.3	0.73	0.56	11.9	17.9
	2.0	2.8	6.5	8.8	0.72	6.4	91.4	3.58	10.1	7.4	0.74	0.52	11.9	19.5
	3.0	6.3	14.6	9.1	0.73	6.6	92.1	3.64	10.2	7.5	0.74	0.49	11.9	20.8
60	1.5	1.6	3.7	9.2	0.72	6.8	92.4	3.75	9.2	7.0	0.76	0.59	11.2	15.6
	2.0	2.7	6.2	9.7	0.73	7.1	93.5	3.86	9.3	7.2	0.77	0.56	11.3	16.5
	3.0	6.2	14.3	10.0	0.74	7.4	94.3	3.93	9.5	7.3	0.77	0.55	11.4	17.4
70	1.5	1.5	3.5	10.0	0.73	7.5	94.5	4.01	8.5	6.9	0.81	0.65	10.7	13.0
	2.0	2.6	6.0	10.5	0.74	7.9	95.7	4.13	8.6	7.0	0.81	0.62	10.7	13.8
	3.0	6.1	14.0	10.8	0.75	8.2	96.6	4.20	8.8	7.1	0.81	0.60	10.9	14.6
80	1.5	1.4	3.2	11.1	0.74	8.5	97.3	4.36	7.9	6.6	0.84	0.72	10.4	11.0
	2.0	2.5	5.8	11.6	0.76	9.0	98.7	4.49	8.0	6.7	0.84	0.69	10.4	11.7
	3.0	6.0	13.9	12.0	0.77	9.3	99.6	4.58	8.2	6.9	0.84	0.67	10.5	12.3
90	1.5	1.3	3.0	12.2	0.76	9.6	100.2	4.71	7.3	6.4	0.87	0.79	10.0	9.3
	2.0	2.4	5.5	12.7	0.77	10.1	101.6	4.85	7.4	6.5	0.87	0.75	10.0	9.9
	3.0	5.9	13.6	13.1	0.78	10.4	102.7	4.93	7.6	6.6	0.87	0.73	10.1	10.4
100	1.5	1.2	2.8	Operation not recommended					Operation not recommended					
	2.0	2.3	5.3						6.9	6.2	0.90	0.83	9.7	8.3
	3.0	5.8	13.4						7.0	6.3	0.90	0.80	9.7	8.8
110	1.5	1.1	2.5						Operation not recommended					
	2.0	2.2	5.1						6.3	5.9	0.93	0.89	9.4	7.1
	3.0	5.7	13.2						6.4	6.0	0.94	0.87	9.4	7.4
120	1.5	1.0	2.3						Operation not recommended					
	2.0	2.1	4.9						5.1	5.0	0.98	0.98	8.5	5.2
	3.0	5.6	12.9						5.2	5.1	0.98	0.95	8.4	5.5

8/9/2018

## ZB012 - Performance Data

### Single Speed with PSC (400 cfm)

EWT °F	WATER FLOW GPM	WPD		HEATING - EAT 70 °F					COOLING - EAT 80/67 °F					
		PSI	FT	HC	KW	HE	LAT	COP	TC	SC	S/T	KW	HR	EER
20	1.5	1.2	2.8	Operation not recommended					Operation not recommended					
	2.5	2.5	5.8	Operation not recommended					Operation not recommended					
	3.5	4.3	9.9	8.3	0.93	5.2	87.3	2.64	Operation not recommended					
30	1.5	1.1	2.6	Operation not recommended					Operation not recommended					
	2.5	2.4	5.5	9.5	0.94	6.3	89.9	2.95	12.6	8.4	0.67	0.60	14.6	20.9
	3.5	4.2	9.7	9.8	0.95	6.5	90.6	3.01	12.7	8.5	0.67	0.57	14.6	22.3
40	1.5	1.1	2.5	Operation not recommended					Operation not recommended					
	2.5	2.4	5.5	10.7	0.98	7.4	92.8	3.21	12.5	8.6	0.69	0.66	14.8	18.9
	3.5	4.1	9.5	11.0	0.99	7.7	93.5	3.27	12.7	8.7	0.69	0.63	14.8	20.2
50	1.5	1.1	2.5	11.4	1.00	8.0	94.4	3.36	12.4	8.6	0.70	0.78	15.1	15.9
	2.5	2.3	5.3	11.9	1.01	8.5	95.6	3.46	12.5	8.8	0.71	0.72	14.9	17.3
	3.5	4.0	9.2	12.3	1.02	8.8	96.5	3.52	12.6	8.9	0.71	0.68	14.9	18.4
60	1.5	1.0	2.3	12.5	1.02	9.0	97.0	3.59	11.8	8.4	0.71	0.82	14.6	14.5
	2.5	2.2	5.0	13.1	1.04	9.6	98.3	3.69	12.0	8.6	0.72	0.78	14.6	15.4
	3.5	3.8	8.8	13.5	1.05	9.9	99.3	3.76	12.2	8.8	0.72	0.75	14.8	16.2
70	1.5	1.0	2.4	13.6	1.05	10.1	99.6	3.81	11.4	8.3	0.73	0.89	14.4	12.8
	2.5	2.2	5.1	14.3	1.07	10.6	101.0	3.92	11.6	8.4	0.73	0.85	14.5	13.6
	3.5	3.7	8.6	14.7	1.08	11.0	102.0	3.99	11.8	8.6	0.73	0.82	14.6	14.3
80	1.5	1.0	2.3	15.0	1.08	11.4	102.8	4.09	10.6	8.0	0.75	0.98	14.0	10.9
	2.5	2.1	4.9	15.7	1.09	12.0	104.4	4.22	10.8	8.1	0.75	0.93	14.0	11.6
	3.5	3.6	8.3	16.2	1.11	12.4	105.5	4.29	11.0	8.3	0.75	0.90	14.1	12.2
90	1.5	0.9	2.1	16.4	1.10	12.7	106.0	4.37	9.8	7.7	0.78	1.06	13.5	9.2
	2.5	2.0	4.6	17.2	1.12	13.3	107.7	4.50	10.0	7.8	0.78	1.02	13.5	9.8
	3.5	3.4	7.9	17.7	1.13	13.8	109.0	4.58	10.2	8.0	0.78	0.98	13.6	10.4
100	1.5	0.9	2.1	Operation not recommended					Operation not recommended					
	2.5	1.9	4.4	Operation not recommended					8.8	7.4	0.85	1.11	12.5	7.9
	3.5	3.3	7.6	Operation not recommended					8.9	7.6	0.85	1.07	12.6	8.3
110	1.5	0.9	2.1	Operation not recommended					Operation not recommended					
	2.5	1.9	4.4	Operation not recommended					7.5	7.1	0.94	1.20	11.6	6.3
	3.5	3.2	7.4	Operation not recommended					7.6	7.2	0.95	1.16	11.6	6.5
120	1.5	0.8	1.8	Operation not recommended					Operation not recommended					
	2.5	1.8	4.2	Operation not recommended					6.8	6.6	0.97	1.29	11.2	5.3
	3.5	3.1	7.2	Operation not recommended					6.9	6.7	0.97	1.25	11.2	5.5

8/9/2018

## ZB015 - Performance Data

### Single Speed with PSC (500 cfm)

EWT °F	Flow GPM	WPD		HEATING - EAT 70°F					COOLING - EAT 80/67°F					
		psi	ft	HC MBtu/h	Power kW	HE MBtu/h	LAT °F	COP	TC MBtu/h	SC MBtu/h	S/T Ratio	Power kW	HR MBtu/h	EER
20	2.0	1.9	4.4	Operation not recommended					Operation not recommended					
	3.0	3.4	7.9	Operation not recommended					Operation not recommended					
	4.0	5.1	11.7	9.2	1.00	5.7	85.0	2.67	Operation not recommended					
30	2.0	1.8	4.2	Operation not recommended					Operation not recommended					
	3.0	3.3	7.6	11.2	1.04	7.7	88.8	3.16	16.9	11.6	0.68	0.69	19.2	24.4
	4.0	5.0	11.5	10.7	1.04	7.2	87.9	3.04	17.1	11.8	0.69	0.65	19.3	26.3
40	2.0	1.8	4.2	Operation not recommended					Operation not recommended					
	3.0	3.2	7.4	12.2	1.06	8.6	90.6	3.38	16.6	11.6	0.70	0.74	19.1	22.3
	4.0	5.0	11.6	12.1	1.06	8.5	90.5	3.36	16.8	11.7	0.70	0.71	19.2	23.8
50	2.0	1.7	3.9	12.9	1.07	9.2	91.8	3.53	16.1	11.5	0.72	0.83	18.9	19.4
	3.0	3.1	7.2	13.2	1.08	9.5	92.5	3.60	16.3	11.6	0.71	0.80	19.0	20.5
	4.0	4.9	11.3	13.5	1.08	9.9	93.1	3.67	16.5	11.7	0.71	0.76	19.1	21.6
60	2.0	1.6	3.7	14.1	1.09	10.3	94.0	3.78	15.3	11.1	0.72	0.92	18.4	16.6
	3.0	3.0	6.9	14.4	1.09	10.7	94.6	3.85	15.5	11.2	0.72	0.89	18.5	17.5
	4.0	4.9	11.3	14.7	1.10	11.0	95.2	3.93	15.7	11.3	0.72	0.85	18.6	18.5
70	2.0	1.6	3.6	15.3	1.11	11.5	96.3	4.03	14.5	10.6	0.73	1.02	18.0	14.3
	3.0	2.9	6.7	15.6	1.11	11.8	96.8	4.10	14.8	10.8	0.73	0.98	18.1	15.1
	4.0	4.8	11.1	15.9	1.12	12.1	97.4	4.17	15.0	10.9	0.72	0.94	18.2	16.0
80	2.0	1.5	3.5	16.2	1.11	12.4	98.1	4.27	13.7	10.2	0.75	1.12	17.5	12.2
	3.0	2.8	6.5	16.5	1.12	12.7	98.6	4.31	13.9	10.4	0.75	1.07	17.6	13.0
	4.0	4.8	11.1	16.8	1.13	13.0	99.1	4.36	14.2	10.5	0.74	1.03	17.7	13.7
90	2.0	1.4	3.2	17.2	1.12	13.4	99.9	4.51	12.9	9.8	0.76	1.22	17.0	10.5
	3.0	2.6	6.0	17.5	1.13	13.6	100.4	4.52	13.1	10.0	0.77	1.17	17.0	11.2
	4.0	4.7	10.9	17.7	1.15	13.8	100.9	4.54	13.3	10.1	0.76	1.13	17.2	11.8
100	2.0	1.3	3.0	Operation not recommended					Operation not recommended					
	3.0	2.4	5.5						12.0	9.5	0.80	1.28	16.3	9.3
	4.0	4.6	10.6						12.1	9.6	0.79	1.24	16.4	9.8
110	2.0	1.2	2.8	Operation not recommended					Operation not recommended					
	3.0	2.3	5.3						10.7	9.0	0.84	1.40	15.5	7.7
	4.0	4.6	10.6						11.0	9.2	0.84	1.36	15.6	8.1
120	2.0	1.1	2.5	Operation not recommended					Operation not recommended					
	3.0	2.2	5.1						9.2	8.5	0.92	1.52	14.4	6.1
	4.0	4.5	10.4						9.4	8.7	0.92	1.48	14.5	6.4

9/5/2012



## ZB018 - Performance Data

### Single Speed with PSC (600 cfm)

EWT °F	Flow GPM	WPD		HEATING - EAT 70°F					COOLING - EAT 80/67°F					
		psi	ft	HC MBtu/h	Power kW	HE MBtu/h	LAT °F	COP	TC MBtu/h	SC MBtu/h	S/T Ratio	Power kW	HR MBtu/h	EER
20	3.0	3.4	7.9	Operation not recommended					Operation not recommended					
	4.0	4.9	11.3	Operation not recommended					Operation not recommended					
	5.0	6.5	15.0	11.7	1.29	7.3	86.1	2.66	Operation not recommended					
30	3.0	3.3	7.6	Operation not recommended					Operation not recommended					
	4.0	4.7	10.9	13.8	1.36	9.2	89.3	2.99	22.1	14.5	0.66	0.92	25.2	24.1
	5.0	6.2	14.2	13.5	1.34	8.9	88.8	2.94	22.4	14.8	0.66	0.86	25.3	26.1
40	3.0	3.3	7.6	Operation not recommended					Operation not recommended					
	4.0	4.7	10.9	15.1	1.38	10.4	91.3	3.20	21.9	14.4	0.66	0.97	25.2	22.5
	5.0	6.2	14.3	15.1	1.37	10.4	91.3	3.22	21.9	14.5	0.66	0.94	25.1	23.4
50	3.0	3.2	7.4	16.2	1.41	11.4	93.0	3.38	21.8	14.4	0.66	1.05	25.4	20.8
	4.0	4.2	9.7	16.5	1.40	11.7	93.4	3.44	21.6	14.3	0.66	1.03	25.1	21.0
	5.0	5.2	11.9	16.7	1.40	11.9	93.8	3.50	21.4	14.3	0.67	1.01	24.9	21.2
60	3.0	3.1	7.2	17.9	1.42	13.0	95.5	3.68	20.7	13.9	0.67	1.17	24.7	17.8
	4.0	4.1	9.4	18.0	1.43	13.2	95.9	3.70	20.5	13.9	0.68	1.15	24.4	17.9
	5.0	5.0	11.6	18.2	1.43	13.4	96.2	3.73	20.2	13.8	0.68	1.13	24.1	18.0
70	3.0	3.0	6.9	19.5	1.44	14.6	98.1	3.97	19.6	13.5	0.69	1.28	24.0	15.3
	4.0	3.9	8.9	19.6	1.45	14.7	98.3	3.96	19.3	13.4	0.69	1.26	23.6	15.3
	5.0	4.7	10.9	19.8	1.47	14.8	98.5	3.95	19.1	13.3	0.70	1.24	23.3	15.4
80	3.0	2.9	6.7	20.3	1.45	15.4	99.4	4.13	18.4	12.8	0.70	1.49	23.5	12.3
	4.0	3.7	8.4	20.6	1.46	15.6	99.8	4.13	18.4	12.9	0.70	1.42	23.2	12.9
	5.0	4.4	10.2	20.8	1.48	15.8	100.1	4.13	18.4	12.9	0.70	1.37	23.1	13.4
90	3.0	2.8	6.5	21.2	1.45	16.2	100.7	4.28	17.1	12.2	0.71	1.63	22.7	10.5
	4.0	3.6	8.3	21.5	1.47	16.5	101.2	4.29	17.4	12.4	0.71	1.56	22.7	11.2
	5.0	4.1	9.5	21.9	1.49	16.8	101.7	4.30	17.8	12.6	0.71	1.51	22.9	11.8
100	3.0	2.7	6.2	Operation not recommended					Operation not recommended					
	4.0	3.5	8.1						16.6	12.0	0.72	1.69	22.3	9.8
	5.0	3.9	9.0						16.8	12.1	0.72	1.63	22.4	10.3
110	3.0	2.6	6.0	Operation not recommended					Operation not recommended					
	4.0	3.1	7.0						15.5	11.4	0.73	1.81	21.7	8.6
	5.0	3.5	8.1						15.8	11.5	0.73	1.76	21.8	9.0
120	3.0	2.5	5.8	Operation not recommended					Operation not recommended					
	4.0	3.0	6.9						13.1	9.8	0.74	1.97	19.8	6.7
	5.0	3.4	7.9						13.4	9.9	0.74	1.91	19.9	7.0

5/1/11

## ZB024 - Performance Data

### Single Speed with PSC (800 cfm)

EWT °F	Flow GPM	WPD		HEATING - EAT 70°F					COOLING - EAT 80/67°F					
		psi	ft	HC MBtu/h	Power kW	HE MBtu/h	LAT °F	COP	TC MBtu/h	SC MBtu/h	S/T Ratio	Power kW	HR MBtu/h	EER
20	3.0	3.3	7.6	Operation not recommended					Operation not recommended					
	4.5	7.0	16.1											
	6.0	10.6	24.4	13.8	1.33	9.3	84.0	3.06						
30	3.0	3.2	7.4	Operation not recommended					Operation not recommended					
	4.5	6.1	14.1	18.7	1.60	13.2	89.6	3.43	29.3	19.6	0.67	1.11	33.1	26.4
	6.0	9.0	20.8	16.8	1.45	11.9	87.4	3.40	29.7	20.0	0.67	1.04	33.3	28.5
40	3.0	3.2	7.4	Operation not recommended					Operation not recommended					
	4.5	6.1	14.1	20.3	1.61	14.8	91.5	3.69	28.8	19.5	0.68	1.25	33.1	23.1
	6.0	9.0	20.8	19.8	1.55	14.5	91.0	3.74	29.4	19.8	0.68	1.18	33.4	25.0
50	3.0	3.1	7.1	21.4	1.61	15.9	92.7	3.89	27.7	19.3	0.70	1.45	32.6	19.1
	4.5	5.5	12.7	22.1	1.63	16.5	93.6	3.97	28.3	19.5	0.69	1.38	33.0	20.5
	6.0	7.9	18.2	22.9	1.66	17.2	94.5	4.04	29.0	19.7	0.68	1.31	33.4	22.2
60	3.0	3.0	6.9	23.8	1.68	18.0	95.5	4.15	26.3	18.5	0.70	1.59	31.7	16.6
	4.5	5.3	12.1	24.2	1.65	18.5	96.0	4.29	27.0	18.8	0.70	1.52	32.2	17.8
	6.0	7.5	17.3	24.6	1.63	19.0	96.4	4.43	27.6	19.1	0.69	1.45	32.6	19.1
70	3.0	2.9	6.7	26.2	1.75	20.2	98.3	4.38	24.9	17.7	0.71	1.72	30.8	14.5
	4.5	4.9	11.3	26.2	1.67	20.5	98.3	4.60	25.6	18.1	0.71	1.66	31.3	15.4
	6.0	6.9	16.0	26.3	1.59	20.8	98.4	4.84	26.3	18.4	0.70	1.59	31.7	16.5
80	3.0	2.8	6.5	27.4	1.77	21.4	99.7	4.54	23.4	17.3	0.74	1.89	29.8	12.4
	4.5	4.7	10.7	27.6	1.74	21.7	100.0	4.65	23.9	17.5	0.73	1.80	30.0	13.3
	6.0	6.5	15.0	27.9	1.71	22.1	100.3	4.77	24.4	17.8	0.73	1.74	30.4	14.0
90	3.0	2.7	6.2	28.6	1.79	22.5	101.1	4.69	21.8	16.8	0.77	2.05	28.8	10.7
	4.5	4.5	10.4	29.1	1.81	22.9	101.7	4.70	22.2	17.0	0.77	1.95	28.8	11.3
	6.0	6.3	14.5	29.5	1.84	23.3	102.2	4.71	22.6	17.2	0.76	1.89	29.1	12.0
100	3.0	2.6	6.0	Operation not recommended					Operation not recommended					
	4.5	4.3	9.9						20.4	16.2	0.79	2.09	27.6	9.8
	6.0	6.0	13.9						20.7	16.3	0.79	2.03	27.7	10.2
110	3.0	2.5	5.8	Operation not recommended					Operation not recommended					
	4.5	4.2	9.6						18.5	15.3	0.83	2.23	26.1	8.3
	6.0	5.8	13.4						18.9	15.5	0.82	2.17	26.3	8.7
120	3.0	2.4	5.5	Operation not recommended					Operation not recommended					
	4.5	4.0	9.2						16.1	13.8	0.86	2.38	24.2	6.8
	6.0	5.6	13.0						16.4	14.0	0.85	2.31	24.3	7.1

5/1/11

## ZB030 - Performance Data

### Single Speed with PSC (1000 cfm)

EWT °F	Flow GPM	WPD		HEATING - EAT 70°F					COOLING - EAT 80/67°F					
		psi	ft	HC MBtu/h	Power kW	HE MBtu/h	LAT °F	COP	TC MBtu/h	SC MBtu/h	S/T Ratio	Power kW	HR MBtu/h	EER
20	4.0	2.5	5.8	Operation not recommended					Operation not recommended					
	6.0	5.2	12.0											
	8.0	7.9	18.3	16.8	1.60	11.4	83.6	3.08						
30	4.0	2.4	5.5	Operation not recommended					Operation not recommended					
	6.0	5.1	11.8	22.2	1.77	16.1	88.5	3.67	35.0	23.1	0.66	1.17	39.0	29.9
	8.0	7.8	18.0	20.5	1.74	14.5	87.0	3.44	35.5	23.6	0.66	1.10	39.2	32.3
40	4.0	2.3	5.3	Operation not recommended					Operation not recommended					
	6.0	4.9	11.3	24.7	1.86	18.3	90.8	3.88	35.1	23.6	0.67	1.32	39.7	26.6
	8.0	7.5	17.3	24.4	1.86	18.0	90.6	3.84	35.8	24.0	0.67	1.24	40.0	28.9
50	4.0	2.3	5.3	26.5	1.93	19.9	92.5	4.02	34.6	23.8	0.69	1.56	39.9	22.1
	6.0	4.9	11.3	27.4	1.96	20.7	93.4	4.10	35.3	24.1	0.68	1.47	40.3	24.0
	8.0	7.5	17.2	28.3	1.98	21.6	94.2	4.19	36.0	24.4	0.68	1.38	40.7	26.1
60	4.0	2.2	5.1	29.6	2.03	22.6	95.4	4.28	32.7	22.9	0.70	1.73	38.6	18.9
	6.0	4.7	10.9	30.6	2.06	23.6	96.4	4.36	33.4	23.2	0.69	1.65	39.0	20.3
	8.0	7.1	16.4	31.7	2.09	24.6	97.3	4.45	34.1	23.5	0.69	1.56	39.4	21.8
70	4.0	2.2	5.0	32.7	2.12	25.4	98.2	4.51	30.9	22.0	0.71	1.90	37.4	16.3
	6.0	4.7	10.9	33.9	2.16	26.5	99.4	4.60	31.5	22.3	0.71	1.82	37.7	17.3
	8.0	7.1	16.4	35.1	2.19	27.6	100.5	4.69	32.1	22.7	0.71	1.74	38.1	18.5
80	4.0	2.1	4.9	35.7	2.19	28.2	101.0	4.78	29.0	21.1	0.73	2.08	36.1	14.0
	6.0	4.6	10.6	36.6	2.22	29.0	101.9	4.82	29.5	21.4	0.73	1.98	36.2	14.9
	8.0	7.0	16.2	37.5	2.25	29.8	102.7	4.87	30.1	21.8	0.72	1.92	36.6	15.7
90	4.0	2.0	4.6	38.7	2.26	31.0	103.8	5.03	27.0	20.2	0.75	2.26	34.8	11.9
	6.0	4.5	10.4	39.3	2.29	31.5	104.4	5.04	27.5	20.5	0.75	2.16	34.8	12.7
	8.0	6.9	16.0	39.9	2.32	32.0	105.0	5.05	28.0	20.8	0.74	2.09	35.2	13.4
100	4.0	1.9	4.4	Operation not recommended					Operation not recommended					
	6.0	4.4	10.2						25.3	19.6	0.77	2.33	33.3	10.8
	8.0	6.8	15.7						25.7	19.8	0.77	2.26	33.4	11.4
110	4.0	1.8	4.2	Operation not recommended					Operation not recommended					
	6.0	4.3	9.9						22.9	18.4	0.80	2.49	31.4	9.2
	8.0	6.7	15.5						23.3	18.7	0.80	2.43	31.6	9.6
120	4.0	1.7	3.9	Operation not recommended					Operation not recommended					
	6.0	4.2	9.7						20.0	16.8	0.84	2.67	29.2	7.5
	8.0	6.6	15.2						20.5	17.1	0.84	2.59	29.3	7.9

5/1/11

## ZB036 - Performance Data

### Single Speed with PSC (1150 cfm)

EWT °F	Flow GPM	WPD		HEATING - EAT 70°F					COOLING - EAT 80/67°F					
		psi	ft	HC MBtu/h	Power kW	HE MBtu/h	LAT °F	COP	TC MBtu/h	SC MBtu/h	S/T Ratio	Power kW	HR MBtu/h	EER
20	5.0	2.1	4.9	Operation not recommended					Operation not recommended					
	7.0	3.7	8.5											
	9.0	5.3	12.2	22.3	1.97	15.6	86.0	3.32						
30	5.0	2.0	4.6	Operation not recommended					Operation not recommended					
	7.0	3.6	8.3	27.3	2.15	20.0	90.0	3.73	41.8	26.6	0.64	1.44	46.7	29.1
	9.0	5.2	12.0	25.6	2.09	18.4	88.6	3.58	42.4	27.1	0.64	1.35	46.9	31.4
40	5.0	2.0	4.6	Operation not recommended					Operation not recommended					
	7.0	3.6	8.3	30.5	2.25	22.8	92.6	3.97	42.2	27.6	0.65	1.61	47.7	26.2
	9.0	5.2	12.0	30.4	2.25	22.7	92.5	3.96	42.7	27.9	0.65	1.52	47.9	28.0
50	5.0	1.9	4.4	32.7	2.32	24.8	94.3	4.13	42.2	28.4	0.67	1.88	48.6	22.5
	7.0	3.5	8.1	34.0	2.36	25.9	95.4	4.21	42.6	28.5	0.67	1.79	48.7	23.8
	9.0	5.1	11.7	35.2	2.41	27.0	96.4	4.29	43.0	28.6	0.66	1.70	48.8	25.3
60	5.0	1.8	4.2	36.9	2.45	28.5	97.7	4.42	40.4	27.9	0.69	2.09	47.5	19.3
	7.0	3.4	7.9	38.1	2.48	29.7	98.7	4.50	40.9	28.0	0.68	2.00	47.7	20.4
	9.0	5.0	11.6	39.4	2.52	30.8	99.7	4.58	41.4	28.1	0.68	1.91	48.0	21.7
70	5.0	1.7	3.9	41.1	2.58	32.3	101.1	4.67	38.6	27.3	0.71	2.30	46.4	16.8
	7.0	3.3	7.6	42.3	2.61	33.4	102.1	4.76	39.2	27.5	0.70	2.21	46.8	17.7
	9.0	4.8	11.1	43.6	2.64	34.6	103.1	4.84	39.9	27.6	0.69	2.13	47.1	18.8
80	5.0	1.6	3.7	44.3	2.67	35.2	103.7	4.87	36.0	26.2	0.73	2.55	44.7	14.1
	7.0	3.2	7.3	45.3	2.70	36.1	104.5	4.92	36.6	26.3	0.72	2.43	44.9	15.0
	9.0	4.7	10.9	46.3	2.73	37.0	105.3	4.97	37.3	26.5	0.71	2.35	45.3	15.8
90	5.0	1.5	3.5	47.5	2.76	38.1	106.3	5.05	33.4	25.0	0.75	2.80	43.0	11.9
	7.0	3.1	7.2	48.2	2.79	38.7	106.8	5.06	34.0	25.2	0.74	2.67	43.1	12.7
	9.0	4.6	10.6	49.0	2.83	39.3	107.4	5.08	34.7	25.4	0.73	2.58	43.5	13.4
100	5.0	1.5	3.5	Operation not recommended					Operation not recommended					
	7.0	3.1	7.2						31.5	24.3	0.77	2.89	41.3	10.9
	9.0	4.6	10.6						32.0	24.5	0.76	2.79	41.5	11.5
110	5.0	1.4	3.2	Operation not recommended					Operation not recommended					
	7.0	2.9	6.7						28.7	23.2	0.81	3.09	39.3	9.3
	9.0	4.4	10.0						29.3	23.5	0.80	3.00	39.6	9.8
120	5.0	1.3	3.0	Operation not recommended					Operation not recommended					
	7.0	2.8	6.5						25.8	22.6	0.88	3.29	37.0	7.8
	9.0	4.3	9.9						26.3	23.0	0.87	3.20	37.2	8.2

5/1/11

## ZB041 - Performance Data

### Single Speed - PSC (1100 CFM)

EWT °F	Flow GPM	WPD		HEATING - EAT 70°F					COOLING - EAT 80/67°F					
		psi	ft	HC MBtu/h	Power kW	HE MBtu/h	LAT °F	COP	TC MBtu/h	SC MBtu/h	S/T Ratio	Power kW	HR MBtu/h	EER
20	5.0	1.6	3.8	Operation not recommended					Operation not recommended					
	8.0	3.6	8.2											
	11.0	8.0	18.5	25.2	2.42	16.9	89.2	3.05						
30	5.0	1.5	3.4	Operation not recommended					Operation not recommended					
	8.0	3.4	7.8	30.9	2.96	20.8	94.0	3.06	45.1	31.7	0.70	1.83	51.3	24.6
	11.0	7.9	18.1	29.7	2.92	19.7	93.0	2.98	45.7	32.3	0.71	1.72	51.6	26.6
40	5.0	1.3	3.0	Operation not recommended					Operation not recommended					
	8.0	3.2	7.5	34.8	3.03	24.4	97.3	3.36	47.2	32.9	0.70	2.01	54.0	23.5
	11.0	7.7	17.8	35.3	3.02	24.9	97.7	3.42	47.8	33.3	0.70	1.89	54.2	25.4
50	5.0	1.2	2.7	37.5	3.10	26.9	99.6	3.55	48.7	33.8	0.69	2.32	56.6	21.0
	8.0	3.1	7.1	39.2	3.11	28.5	101.0	3.69	49.3	34.1	0.69	2.19	56.8	22.6
	11.0	7.5	17.4	40.8	3.12	30.2	102.3	3.83	49.9	34.3	0.69	2.05	56.9	24.3
60	5.0	1.0	2.3	42.7	3.16	31.9	103.9	3.96	46.1	32.8	0.71	2.53	54.7	18.2
	8.0	2.9	6.7	44.5	3.19	33.6	105.4	4.09	46.8	33.1	0.71	2.41	55.0	19.5
	11.0	7.4	17.0	46.3	3.22	35.3	106.9	4.21	47.6	33.4	0.70	2.29	55.4	20.8
70	5.0	0.9	2.0	47.9	3.22	36.9	108.3	4.36	43.4	31.7	0.73	2.73	52.7	15.9
	8.0	2.8	6.4	49.8	3.27	38.6	109.9	4.46	44.4	32.1	0.72	2.63	53.3	16.9
	11.0	7.2	16.7	51.7	3.32	40.4	111.5	4.56	45.3	32.4	0.72	2.52	53.9	18.0
80	5.0	0.7	1.6	53.5	3.33	42.1	113.0	4.71	40.9	30.8	0.75	2.99	51.1	13.7
	8.0	2.6	6.0	54.9	3.37	43.4	114.2	4.77	41.7	31.0	0.74	2.85	51.4	14.6
	11.0	7.1	16.3	56.3	3.42	44.6	115.4	4.82	42.6	31.3	0.74	2.76	52.0	15.4
90	5.0	0.5	1.2	59.1	3.43	47.4	117.7	5.04	38.4	29.8	0.78	3.25	49.5	11.8
	8.0	2.5	5.7	60.0	3.48	48.1	118.5	5.06	39.0	29.9	0.77	3.10	49.6	12.6
	11.0	6.9	16.0	60.9	3.52	48.9	119.3	5.07	39.8	30.2	0.76	3.00	50.0	13.3
100	5.0	0.4	0.9	Operation not recommended					Operation not recommended					
	8.0	2.3	5.3						36.2	28.7	0.79	3.46	48.0	10.5
	11.0	6.8	15.6						36.8	29.0	0.79	3.35	48.2	11.0
110	5.0	0.4	0.9						Operation not recommended					
	8.0	2.1	4.9						33.0	27.3	0.83	3.80	46.0	8.7
	11.0	6.6	15.2						33.7	27.7	0.82	3.70	46.3	9.1
120	5.0	0.4	0.9	Operation not recommended										
	8.0	2.0	4.6	29.8	26.2	0.88	4.22	44.2	7.0					
	11.0	6.5	14.9	30.4	26.6	0.88	4.10	44.4	7.4					

## ZB042 - Performance Data

### Single Speed with PSC (1400 cfm)

EWT °F	Flow GPM	WPD		HEATING - EAT 70°F					COOLING - EAT 80/67°F					
		psi	ft	HC MBtu/h	Power kW	HE MBtu/h	LAT °F	COP	TC MBtu/h	SC MBtu/h	S/T Ratio	Power kW	HR MBtu/h	EER
20	5.0	2.2	5.1	Operation not recommended					Operation not recommended					
	8.0	4.9	11.3	Operation not recommended					Operation not recommended					
	11.0	7.6	17.6	25.4	2.27	17.7	84.8	3.28	Operation not recommended					
30	5.0	2.1	4.9	Operation not recommended					Operation not recommended					
	8.0	4.8	11.1	31.3	2.50	22.8	88.7	3.67	48.8	33.4	0.68	1.72	54.7	28.3
	11.0	7.5	17.2	30.4	2.44	22.1	88.1	3.65	49.5	34.1	0.69	1.62	55.0	30.6
40	5.0	2.1	4.9	Operation not recommended					Operation not recommended					
	8.0	4.8	11.1	35.1	2.62	26.2	91.2	3.93	49.5	34.0	0.69	1.93	56.1	25.6
	11.0	7.5	17.3	35.8	2.61	26.9	91.7	4.01	50.4	34.5	0.68	1.81	56.6	27.9
50	5.0	2.0	4.6	37.3	2.68	28.1	92.7	4.08	49.2	34.0	0.69	2.29	57.0	21.4
	8.0	4.7	10.9	39.2	2.73	29.9	93.9	4.20	50.2	34.5	0.69	2.15	57.6	23.4
	11.0	7.4	17.0	41.1	2.79	31.6	95.2	4.33	51.3	35.0	0.68	2.00	58.1	25.7
60	5.0	1.9	4.4	42.3	2.81	32.7	96.0	4.41	46.3	33.1	0.71	2.52	54.9	18.4
	8.0	4.6	10.5	44.2	2.86	34.4	97.2	4.53	47.4	33.5	0.71	2.38	55.5	19.9
	11.0	7.2	16.6	46.1	2.91	36.2	98.5	4.64	48.4	33.8	0.70	2.24	56.1	21.7
70	5.0	1.8	4.2	47.3	2.94	37.3	99.3	4.71	43.5	32.2	0.74	2.74	52.9	15.9
	8.0	4.5	10.4	49.2	2.99	39.0	100.5	4.82	44.5	32.4	0.73	2.61	53.4	17.1
	11.0	7.0	16.2	51.1	3.04	40.7	101.8	4.93	45.5	32.6	0.72	2.48	54.0	18.4
80	5.0	1.7	3.9	52.8	3.05	42.4	102.9	5.07	40.9	31.1	0.76	2.94	50.9	13.9
	8.0	4.5	10.4	54.1	3.09	43.6	103.8	5.13	41.7	31.3	0.75	2.81	51.2	14.8
	11.0	6.8	15.7	55.5	3.14	44.8	104.7	5.19	42.6	31.6	0.74	2.72	51.8	15.7
90	5.0	1.6	3.7	58.2	3.16	47.4	106.5	5.40	38.2	30.1	0.79	3.21	49.2	11.9
	8.0	4.4	10.2	59.1	3.20	48.2	107.1	5.42	38.8	30.3	0.78	3.06	49.3	12.7
	11.0	6.6	15.3	60.0	3.24	49.0	107.7	5.43	39.6	30.6	0.77	2.96	49.7	13.4
100	5.0	1.5	3.5	Operation not recommended					Operation not recommended					
	8.0	4.3	9.9	Operation not recommended					36.0	29.2	0.81	3.31	47.3	10.9
	11.0	6.2	14.3	Operation not recommended					36.6	29.4	0.80	3.20	47.5	11.4
110	5.0	1.4	3.2	Operation not recommended					Operation not recommended					
	8.0	4.2	9.7	Operation not recommended					32.9	27.8	0.84	3.53	44.9	9.3
	11.0	6.1	14.2	Operation not recommended					33.6	28.2	0.84	3.44	45.3	9.8
120	5.0	1.4	3.2	Operation not recommended					Operation not recommended					
	8.0	4.2	9.7	Operation not recommended					30.2	25.8	0.86	3.76	43.0	8.0
	11.0	6.1	14.1	Operation not recommended					30.8	26.2	0.85	3.65	43.3	8.4

9/18/11

## ZB048 - Performance Data

### Single Speed with PSC (1600 cfm)

EWT °F	Flow GPM	WPD		HEATING - EAT 70°F					COOLING - EAT 80/67°F					
		psi	ft	HC MBtu/h	Power kW	HE MBtu/h	LAT °F	COP	TC MBtu/h	SC MBtu/h	S/T Ratio	Power kW	HR MBtu/h	EER
20	6.0	2.8	6.5	Operation not recommended					Operation not recommended					
	9.0	6.1	14.1											
	12.0	10.4	24.1	31.2	2.86	21.5	86.1	3.20						
30	6.0	2.7	6.2	Operation not recommended					Operation not recommended					
	9.0	6.0	13.9	36.6	3.00	26.3	89.2	3.57	56.2	38.3	0.68	2.26	63.9	24.8
	12.0	9.5	22.0	36.3	3.05	25.9	89.0	3.49	56.9	39.1	0.69	2.13	64.2	26.8
40	6.0	2.7	6.2	Operation not recommended					Operation not recommended					
	9.0	6.0	13.9	41.5	3.19	30.6	92.0	3.81	58.1	39.5	0.68	2.51	66.7	23.1
	12.0	9.4	21.7	42.6	3.26	31.5	92.7	3.84	58.9	40.0	0.68	2.36	67.0	24.9
50	6.0	2.6	6.0	45.0	3.33	33.7	94.1	3.96	59.2	40.4	0.68	2.92	69.2	20.3
	9.0	5.9	13.6	47.0	3.39	35.4	95.2	4.06	60.0	40.7	0.68	2.76	69.5	21.7
	12.0	9.3	21.4	48.9	3.46	37.1	96.3	4.14	60.9	41.0	0.67	2.60	69.7	23.4
60	6.0	2.5	5.8	51.3	3.54	39.2	97.7	4.25	56.1	38.9	0.69	3.19	67.0	17.6
	9.0	5.8	13.4	53.7	3.61	41.3	99.1	4.35	57.1	39.2	0.69	3.03	67.4	18.8
	12.0	9.2	21.3	56.0	3.69	43.5	100.4	4.45	58.0	39.5	0.68	2.88	67.9	20.1
70	6.0	2.4	5.5	57.6	3.76	44.8	101.4	4.50	53.0	37.4	0.70	3.45	64.8	15.4
	9.0	5.4	12.5	60.4	3.84	47.3	103.0	4.62	54.1	37.7	0.70	3.31	65.4	16.4
	12.0	8.5	19.6	63.2	3.92	49.8	104.6	4.73	55.2	38.0	0.69	3.16	66.0	17.5
80	6.0	2.3	5.3	65.0	3.97	51.4	105.6	4.79	49.4	36.0	0.73	3.73	62.1	13.2
	9.0	5.3	12.2	66.9	4.04	53.1	106.7	4.85	50.3	36.3	0.72	3.56	62.4	14.1
	12.0	8.4	19.4	68.8	4.11	54.8	107.8	4.91	51.3	36.6	0.71	3.44	63.1	14.9
90	6.0	2.2	5.1	72.3	4.19	58.0	109.8	5.06	45.8	34.7	0.76	4.04	59.5	11.3
	9.0	5.2	12.0	73.4	4.25	58.9	110.5	5.07	46.5	34.9	0.75	3.85	59.6	12.1
	12.0	8.3	19.2	74.5	4.30	59.9	111.1	5.08	47.4	35.2	0.74	3.73	60.1	12.7
100	6.0	2.1	4.9	Operation not recommended					Operation not recommended					
	9.0	5.2	12.0						42.8	33.1	0.77	4.12	56.8	10.4
	12.0	8.2	18.9						43.4	33.4	0.77	3.98	57.0	10.9
110	6.0	2.0	4.6						Operation not recommended					
	9.0	5.1	11.8						38.6	31.1	0.81	4.36	53.5	8.9
	12.0	8.1	18.8						39.4	31.6	0.80	4.24	53.9	9.3
120	6.0	1.9	4.4						Operation not recommended					
	9.0	5.0	11.6						34.7	29.4	0.85	4.61	50.4	7.5
	12.0	8.0	18.5						35.4	29.9	0.84	4.48	50.7	7.9

5/1/11

## ZB060 - Performance Data

### Single Speed with PSC (2000 cfm)

EWT °F	Flow GPM	WPD		HEATING - EAT 70°F					COOLING - EAT 80/67°F					
		psi	ft	HC MBtu/h	Power kW	HE MBtu/h	LAT °F	COP	TC MBtu/h	SC MBtu/h	S/T Ratio	Power kW	HR MBtu/h	EER
20	9.0	4.6	10.6	Operation not recommended					Operation not recommended					
	12.0	7.3	16.9	Operation not recommended					Operation not recommended					
	15.0	10.0	23.1	35.5	3.50	23.5	85.3	2.97	Operation not recommended					
30	9.0	4.5	10.4	Operation not recommended					Operation not recommended					
	12.0	6.5	15.0	41.2	3.64	28.8	88.1	3.32	64.9	42.4	0.65	2.66	74.0	24.4
	15.0	8.6	19.8	41.2	3.69	28.6	88.1	3.27	65.8	43.3	0.66	2.50	74.3	26.3
40	9.0	4.5	10.4	Operation not recommended					Operation not recommended					
	12.0	6.5	15.0	46.4	3.90	33.1	90.6	3.49	66.2	44.3	0.67	2.93	76.2	22.6
	15.0	8.6	19.9	47.5	3.96	34.0	91.1	3.51	67.0	44.7	0.67	2.79	76.5	24.0
50	9.0	4.4	10.0	50.6	4.10	36.7	92.7	3.62	66.8	46.2	0.69	3.31	78.1	20.2
	12.0	6.3	14.4	52.2	4.16	38.0	93.4	3.67	67.5	46.1	0.68	3.20	78.4	21.1
	15.0	8.1	18.8	53.7	4.23	39.3	94.2	3.72	68.1	46.1	0.68	3.09	78.6	22.1
60	9.0	4.3	9.9	56.8	4.37	41.9	95.7	3.81	63.5	45.0	0.71	3.63	75.9	17.5
	12.0	6.2	14.3	59.2	4.46	43.9	96.8	3.89	64.2	45.0	0.70	3.53	76.2	18.2
	15.0	8.0	18.5	61.5	4.56	46.0	98.0	3.96	64.9	45.1	0.70	3.42	76.5	19.0
70	9.0	4.2	9.6	63.0	4.63	47.2	98.7	3.98	60.3	43.7	0.73	3.96	73.7	15.2
	12.0	6.1	14.1	66.1	4.76	49.9	100.2	4.07	60.9	43.9	0.72	3.85	74.1	15.8
	15.0	7.9	18.2	69.3	4.89	52.6	101.8	4.16	61.6	44.1	0.72	3.75	74.4	16.4
80	9.0	4.1	9.5	70.6	4.91	53.9	102.4	4.22	56.2	41.8	0.74	4.44	71.4	12.7
	12.0	6.0	13.9	72.8	5.00	55.8	103.5	4.27	57.0	42.1	0.74	4.24	71.4	13.4
	15.0	7.8	18.0	75.0	5.10	57.6	104.6	4.31	57.9	42.3	0.73	4.10	71.8	14.1
90	9.0	4.0	9.2	78.3	5.18	60.6	106.2	4.43	52.2	39.9	0.76	4.82	68.6	10.8
	12.0	5.9	13.6	79.5	5.25	61.6	106.7	4.44	53.0	40.2	0.76	4.60	68.7	11.5
	15.0	7.7	17.8	80.7	5.31	62.6	107.3	4.45	54.1	40.5	0.75	4.45	69.2	12.2
100	9.0	3.9	9.0	Operation not recommended					Operation not recommended					
	12.0	5.8	13.4						48.8	38.5	0.79	4.96	65.7	9.8
	15.0	7.6	17.6						49.5	38.8	0.78	4.80	65.9	10.3
110	9.0	3.8	8.8	Operation not recommended					Operation not recommended					
	12.0	5.7	13.2						44.1	36.5	0.83	5.31	62.2	8.3
	15.0	7.5	17.3						45.0	37.1	0.82	5.16	62.6	8.7
120	9.0	3.7	8.5	Operation not recommended					Operation not recommended					
	12.0	5.6	12.9						39.7	34.6	0.87	5.68	59.1	7.0
	15.0	7.4	17.1						40.6	35.1	0.86	5.51	59.4	7.4

5/1/11



## ZB070 - Performance Data

### Single Speed with PSC (2200 cfm)

EWT °F	Flow GPM	WPD		HEATING - EAT 70°F					COOLING - EAT 80/67°F					
		psi	ft	HC MBtu/h	Power kW	HE MBtu/h	LAT °F	COP	TC MBtu/h	SC MBtu/h	S/T Ratio	Power kW	HR MBtu/h	EER
20	12.0	5.8	13.4	Operation not recommended					Operation not recommended					
	15.0	9.1	20.9	Operation not recommended					Operation not recommended					
	18.0	12.3	28.4	42.5	3.90	29.2	86.7	3.20	Operation not recommended					
30	12.0	5.7	13.2	Operation not recommended					Operation not recommended					
	15.0	8.9	20.4	50.2	4.15	36.0	90.1	3.54	66.2	41.5	0.63	2.90	76.1	22.8
	18.0	12.0	27.7	48.6	4.15	34.5	89.4	3.43	67.1	42.4	0.63	2.73	76.4	24.6
40	12.0	5.7	13.2	Operation not recommended					Operation not recommended					
	15.0	8.9	20.4	56.9	4.37	42.0	93.1	3.81	71.3	46.6	0.65	3.16	82.0	22.6
	18.0	12.0	27.7	57.0	4.39	42.0	93.1	3.81	71.4	46.5	0.65	3.03	81.8	23.6
50	12.0	5.6	13.0	63.3	4.57	47.7	95.9	4.06	76.8	52.6	0.68	3.50	88.8	21.9
	15.0	8.6	19.8	64.3	4.60	48.7	96.4	4.10	76.3	51.6	0.68	3.41	87.9	22.4
	18.0	11.5	26.6	65.4	4.63	49.6	96.8	4.14	75.7	50.6	0.67	3.33	87.1	22.8
60	12.0	5.5	12.7	72.1	4.81	55.7	99.8	4.40	74.2	52.2	0.70	3.88	87.4	19.1
	15.0	8.4	19.3	73.6	4.85	57.0	100.4	4.45	74.2	51.7	0.70	3.79	87.1	19.6
	18.0	11.2	25.9	75.0	4.88	58.3	101.1	4.50	74.2	51.3	0.69	3.70	86.8	20.0
70	12.0	5.4	12.5	80.9	5.05	63.7	103.7	4.70	71.5	51.8	0.72	4.26	86.1	16.8
	15.0	8.2	18.9	82.8	5.09	65.4	104.5	4.76	72.1	51.9	0.72	4.17	86.3	17.3
	18.0	11.0	25.5	84.6	5.14	67.1	105.3	4.83	72.6	51.9	0.72	4.08	86.5	17.8
80	12.0	5.3	12.2	88.9	5.23	71.1	107.2	4.99	66.5	50.2	0.76	4.86	83.0	13.7
	15.0	7.9	18.2	90.6	5.28	72.5	107.9	5.02	67.2	50.3	0.75	4.63	83.0	14.5
	18.0	10.5	24.3	92.2	5.34	74.0	108.7	5.06	68.1	50.5	0.74	4.48	83.4	15.2
90	12.0	5.2	12.0	96.9	5.40	78.4	110.7	5.26	61.4	48.6	0.79	5.30	79.5	11.6
	15.0	7.7	17.7	98.4	5.47	79.7	111.4	5.27	62.3	48.8	0.78	5.05	79.6	12.3
	18.0	10.1	23.4	99.9	5.54	81.0	112.0	5.28	63.6	49.1	0.77	4.89	80.3	13.0
100	12.0	5.1	11.8	Operation not recommended					Operation not recommended					
	15.0	7.3	16.7	Operation not recommended					57.6	46.3	0.80	5.45	76.2	10.6
	18.0	9.4	21.7	Operation not recommended					58.5	46.7	0.80	5.27	76.4	11.1
110	12.0	5.0	11.6	Operation not recommended					Operation not recommended					
	15.0	6.7	15.5	Operation not recommended					52.3	43.7	0.84	5.81	72.1	9.0
	18.0	8.4	19.5	Operation not recommended					53.3	44.4	0.83	5.65	72.6	9.4
120	12.0	4.9	11.3	Operation not recommended					Operation not recommended					
	15.0	6.6	15.2	Operation not recommended					47.5	41.8	0.88	6.21	68.7	7.6
	18.0	8.3	19.1	Operation not recommended					48.5	42.4	0.87	6.03	69.1	8.0

5/1/11

## ZB015 - Performance Data

### Single Speed with Variable Speed ECM or 5-Speed ECM (500 cfm)

EWT °F	Flow GPM	WPD		HEATING - EAT 70°F					COOLING - EAT 80/67°F					
		psi	ft	HC MBtu/h	Power kW	HE MBtu/h	LAT °F	COP	TC MBtu/h	SC MBtu/h	S/T Ratio	Power kW	HR MBtu/h	EER
20	2.0	1.9	4.4	Operation not recommended					Operation not recommended					
	3.0	3.4	7.9											
	4.0	5.1	11.7	9.2	0.95	5.9	85.0	2.82						
30	2.0	1.8	4.2	Operation not recommended					Operation not recommended					
	3.0	3.3	7.6	11.2	0.99	7.8	88.8	3.32	16.9	11.6	0.68	0.64	19.1	26.4
	4.0	5.0	11.5	10.7	1.00	7.3	87.9	3.15	17.1	11.8	0.69	0.60	19.2	28.5
40	2.0	1.8	4.2	Operation not recommended					Operation not recommended					
	3.0	3.2	7.4	12.2	1.01	8.7	90.6	3.53	16.6	11.6	0.70	0.69	18.9	24.0
	4.0	5.0	11.6	12.1	1.02	8.7	90.5	3.49	16.8	11.7	0.70	0.66	19.0	25.6
50	2.0	1.7	3.9	12.9	1.02	9.4	91.8	3.70	16.1	11.5	0.72	0.78	18.7	20.6
	3.0	3.1	7.2	13.2	1.03	9.7	92.5	3.76	16.3	11.6	0.71	0.75	18.8	21.8
	4.0	4.9	11.3	13.5	1.04	10.0	93.1	3.82	16.5	11.7	0.71	0.71	18.9	23.2
60	2.0	1.6	3.7	14.1	1.04	10.5	94.0	3.96	15.3	11.1	0.72	1.38	20.0	11.1
	3.0	3.0	6.9	14.4	1.05	10.8	94.6	4.02	15.5	11.2	0.72	1.09	19.2	14.2
	4.0	4.9	11.3	14.7	1.06	11.1	95.2	4.07	15.7	11.3	0.72	0.80	18.5	19.7
70	2.0	1.6	3.6	15.3	1.06	11.6	96.3	4.22	14.5	10.6	0.73	1.98	21.3	7.3
	3.0	2.9	6.7	15.6	1.07	11.9	96.8	4.26	14.8	10.8	0.73	1.44	19.7	10.3
	4.0	4.8	11.1	15.9	1.08	12.2	97.4	4.31	15.0	10.9	0.72	0.89	18.0	16.9
80	2.0	1.5	3.5	16.2	1.07	12.6	98.1	4.46	13.7	10.2	0.75	1.07	17.3	12.8
	3.0	2.8	6.5	16.5	1.08	12.8	98.6	4.49	13.9	10.4	0.75	1.02	17.4	13.7
	4.0	4.8	11.1	16.8	1.09	13.1	99.1	4.52	14.2	10.5	0.74	0.99	17.5	14.4
90	2.0	1.4	3.2	17.2	1.07	13.6	99.9	4.70	12.9	9.8	0.76	1.17	16.8	11.0
	3.0	2.6	6.0	17.5	1.09	13.8	100.4	4.72	13.1	10.0	0.77	1.12	16.9	11.7
	4.0	4.7	10.9	17.7	1.10	14.0	100.9	4.73	13.3	10.1	0.76	1.08	17.0	12.3
100	2.0	1.3	3.0	Operation not recommended					Operation not recommended					
	3.0	2.4	5.5						12.0	9.5	0.80	1.22	16.1	9.8
	4.0	4.6	10.6						12.1	9.6	0.79	1.19	16.2	10.2
110	2.0	1.2	2.8	Operation not recommended					Operation not recommended					
	3.0	2.3	5.3						10.7	9.0	0.84	1.33	15.3	8.1
	4.0	4.6	10.6						11.0	9.2	0.84	1.29	15.4	8.5
120	2.0	1.1	2.5	Operation not recommended					Operation not recommended					
	3.0	2.2	5.1						9.2	8.5	0.92	1.46	14.2	6.3
	4.0	4.5	10.4						9.4	8.7	0.92	1.42	14.3	6.6

9/5/2012

## ZB018 - Performance Data

### Single Speed with Variable Speed ECM or 5-Speed ECM (600 cfm)

EWT °F	Flow GPM	WPD		HEATING - EAT 70°F					COOLING - EAT 80/67°F					
		psi	ft	HC MBtu/h	Power kW	HE MBtu/h	LAT °F	COP	TC MBtu/h	SC MBtu/h	S/T Ratio	Power kW	HR MBtu/h	EER
20	3.0	3.4	7.9	Operation not recommended					Operation not recommended					
	4.0	4.9	11.3	Operation not recommended					Operation not recommended					
	5.0	6.5	15.0	11.7	1.24	7.5	86.1	2.78	Operation not recommended					
30	3.0	3.3	7.6	Operation not recommended					Operation not recommended					
	4.0	4.7	10.9	13.8	1.31	9.4	89.3	3.10	22.1	14.5	0.66	0.71	24.5	31.4
	5.0	6.2	14.2	13.5	1.28	9.1	88.8	3.08	22.4	14.8	0.66	0.66	24.7	33.9
40	3.0	3.3	7.6	Operation not recommended					Operation not recommended					
	4.0	4.7	10.9	15.1	1.33	10.6	91.3	3.33	21.9	14.4	0.66	0.84	24.7	26.2
	5.0	6.2	14.3	15.1	1.31	10.6	91.3	3.37	21.9	14.5	0.66	0.80	24.7	27.3
50	3.0	3.2	7.4	16.2	1.36	11.6	93.0	3.49	21.8	14.4	0.66	0.99	25.2	22.0
	4.0	4.2	9.7	16.5	1.35	11.8	93.4	3.57	21.6	14.3	0.66	0.97	24.9	22.4
	5.0	5.2	11.9	16.7	1.34	12.1	93.8	3.65	21.4	14.3	0.67	0.94	24.6	22.7
60	3.0	3.1	7.2	17.9	1.38	13.2	95.5	3.80	20.7	13.9	0.67	1.11	24.5	18.6
	4.0	4.1	9.4	18.0	1.38	13.4	95.9	3.85	20.5	13.9	0.68	1.08	24.2	18.9
	5.0	5.0	11.6	18.2	1.38	13.6	96.2	3.89	20.2	13.8	0.68	1.06	23.9	19.1
70	3.0	3.0	6.9	19.5	1.39	14.8	98.1	4.11	19.6	13.5	0.69	1.23	23.8	15.9
	4.0	3.9	8.9	19.6	1.40	14.9	98.3	4.11	19.3	13.4	0.69	1.20	23.4	16.1
	5.0	4.7	10.9	19.8	1.41	15.0	98.5	4.12	19.1	13.3	0.70	1.18	23.1	16.2
80	3.0	2.9	6.7	20.3	1.39	15.6	99.4	4.28	18.4	12.8	0.70	1.42	23.2	13.0
	4.0	3.7	8.4	20.6	1.41	15.8	99.8	4.29	18.4	12.9	0.70	1.35	23.0	13.6
	5.0	4.4	10.2	20.8	1.42	16.0	100.1	4.30	18.4	12.9	0.70	1.31	22.9	14.1
90	3.0	2.8	6.5	21.2	1.39	16.4	100.7	4.46	17.1	12.2	0.71	1.56	22.5	11.0
	4.0	3.6	8.3	21.5	1.41	16.7	101.2	4.47	17.4	12.4	0.71	1.49	22.5	11.7
	5.0	4.1	9.5	21.9	1.43	17.0	101.7	4.48	17.8	12.6	0.71	1.44	22.7	12.3
100	3.0	2.7	6.2	Operation not recommended					Operation not recommended					
	4.0	3.5	8.1	Operation not recommended					16.6	12.0	0.72	1.62	22.1	10.2
	5.0	3.9	9.0	Operation not recommended					16.8	12.1	0.72	1.57	22.2	10.7
110	3.0	2.6	6.0	Operation not recommended					Operation not recommended					
	4.0	3.1	7.0	Operation not recommended					15.5	11.4	0.73	1.74	21.5	8.9
	5.0	3.5	8.1	Operation not recommended					15.8	11.5	0.73	1.70	21.6	9.3
120	3.0	2.5	5.8	Operation not recommended					Operation not recommended					
	4.0	3.0	6.9	Operation not recommended					13.1	9.8	0.74	1.91	19.6	6.9
	5.0	3.4	7.9	Operation not recommended					13.4	9.9	0.74	1.85	19.7	7.2

5/1/11

## ZB024 - Performance Data

### Single Speed with Variable Speed ECM or 5-Speed ECM (800 cfm)

EWT °F	Flow GPM	WPD		HEATING - EAT 70°F					COOLING - EAT 80/67°F					
		psi	ft	HC MBtu/h	Power kW	HE MBtu/h	LAT °F	COP	TC MBtu/h	SC MBtu/h	S/T Ratio	Power kW	HR MBtu/h	EER
20	3.0	3.3	7.6	Operation not recommended					Operation not recommended					
	4.5	7.0	16.1											
	6.0	10.6	24.4	13.8	1.21	9.7	84.0	3.35						
30	3.0	3.2	7.4	Operation not recommended					Operation not recommended					
	4.5	6.1	14.1	18.7	1.40	13.9	89.6	3.92	29.3	19.6	0.67	0.99	32.7	29.8
	6.0	9.0	20.8	16.8	1.33	12.3	87.4	3.70	29.7	20.0	0.67	0.93	32.9	32.1
40	3.0	3.2	7.4	Operation not recommended					Operation not recommended					
	4.5	6.1	14.1	20.3	1.46	15.4	91.5	4.10	28.8	19.5	0.68	1.18	32.9	24.5
	6.0	9.0	20.8	19.8	1.44	14.9	91.0	4.05	29.4	19.8	0.68	1.17	33.3	25.2
50	3.0	3.1	7.1	21.4	1.49	16.3	92.7	4.20	27.7	19.3	0.70	1.34	32.2	20.7
	4.5	5.5	12.7	22.1	1.52	16.9	93.6	4.28	28.3	19.5	0.69	1.37	33.0	20.7
	6.0	7.9	18.2	22.9	1.54	17.6	94.5	4.35	29.0	19.7	0.68	1.41	33.8	20.6
60	3.0	3.0	6.9	23.8	1.56	18.4	95.5	4.46	26.3	18.5	0.70	1.47	31.3	17.9
	4.5	5.3	12.1	24.2	1.58	18.8	96.0	4.48	27.0	18.8	0.70	1.46	31.9	18.5
	6.0	7.5	17.3	24.6	1.60	19.1	96.4	4.50	27.6	19.1	0.69	1.44	32.5	19.2
70	3.0	2.9	6.7	26.2	1.63	20.6	98.3	4.70	24.9	17.7	0.71	1.61	30.4	15.5
	4.5	4.9	11.3	26.2	1.64	20.6	98.3	4.67	25.6	18.1	0.71	1.54	30.9	16.6
	6.0	6.9	16.0	26.3	1.66	20.6	98.4	4.64	26.3	18.4	0.70	1.48	31.3	17.8
80	3.0	2.8	6.5	27.4	1.65	21.8	99.7	4.86	23.4	17.2	0.74	1.76	29.4	13.3
	4.5	4.7	10.7	27.6	1.67	21.9	100.0	4.85	23.9	17.5	0.73	1.68	29.6	14.2
	6.0	6.5	15.0	27.9	1.69	22.1	100.3	4.84	24.4	17.8	0.73	1.62	30.0	15.1
90	3.0	2.7	6.2	28.6	1.68	22.9	101.1	5.00	21.8	16.7	0.77	1.92	28.4	11.4
	4.5	4.5	10.4	29.1	1.70	23.3	101.7	5.02	22.2	16.9	0.76	1.83	28.4	12.1
	6.0	6.3	14.5	29.5	1.72	23.7	102.2	5.03	22.6	17.2	0.76	1.77	28.6	12.8
100	3.0	2.6	6.0	Operation not recommended					Operation not recommended					
	4.5	4.3	9.9						20.4	16.2	0.79	1.97	27.2	10.3
	6.0	6.0	13.9						20.7	16.3	0.79	1.91	27.3	10.9
110	3.0	2.5	5.8	Operation not recommended					Operation not recommended					
	4.5	4.2	9.6						18.5	15.3	0.83	2.11	25.7	8.8
	6.0	5.8	13.4						18.9	15.5	0.82	2.05	25.9	9.2
120	3.0	2.4	5.5	Operation not recommended					Operation not recommended					
	4.5	4.0	9.2						16.1	13.8	0.86	2.26	23.8	7.1
	6.0	5.6	13.0						16.4	14.0	0.85	2.19	23.9	7.5

5/1/11

## ZB030 - Performance Data

### Single Speed with Variable Speed ECM or 5-Speed ECM (1000 cfm)

EWT °F	Flow GPM	WPD		HEATING - EAT 70°F					COOLING - EAT 80/67°F					
		psi	ft	HC MBtu/h	Power kW	HE MBtu/h	LAT °F	COP	TC MBtu/h	SC MBtu/h	S/T Ratio	Power kW	HR MBtu/h	EER
20	8.0	2.5	5.8	Operation not recommended					Operation not recommended					
	4.0	5.2	12.0											
	6.0	7.9	18.3	16.8	1.46	11.9	83.6	3.39						
30	8.0	2.4	5.5	Operation not recommended					Operation not recommended					
	4.0	5.1	11.8	22.2	1.63	16.6	88.5	3.99	35.0	23.1	0.66	1.03	38.5	34.1
	6.0	7.8	18.0	20.5	1.60	15.0	87.0	3.76	35.5	23.6	0.66	0.96	38.8	36.8
40	8.0	2.3	5.3	Operation not recommended					Operation not recommended					
	4.0	4.9	11.3	24.7	1.72	18.8	90.8	4.21	35.1	23.6	0.67	1.18	39.2	29.8
	6.0	7.5	17.3	24.4	1.72	18.5	90.6	4.16	35.8	24.0	0.67	1.10	39.5	32.4
50	4.0	2.3	5.3	26.5	1.79	20.4	92.5	4.34	34.6	23.8	0.69	1.43	39.4	24.2
	6.0	4.9	11.3	27.4	1.81	21.2	93.4	4.43	35.3	24.1	0.68	1.33	39.8	26.4
	8.0	7.5	17.2	28.3	1.84	22.0	94.2	4.51	36.0	24.4	0.68	1.24	40.3	29.1
60	8.0	2.2	5.1	29.6	1.88	23.1	95.4	4.60	32.7	22.9	0.70	1.60	38.2	20.5
	4.0	4.7	10.9	30.6	1.91	24.1	96.4	4.69	34.3	23.8	0.69	1.39	39.1	24.7
	6.0	7.1	16.4	31.7	1.94	25.1	97.3	4.78	34.1	23.5	0.69	1.42	38.9	23.9
70	8.0	2.2	5.0	32.7	1.98	25.9	98.2	4.84	30.9	22.0	0.71	1.77	37.0	17.5
	4.0	4.7	10.9	33.9	2.01	27.0	99.4	4.93	33.3	23.5	0.70	1.45	38.3	23.1
	6.0	7.1	16.4	35.1	2.05	28.1	100.5	5.01	32.1	22.7	0.71	1.61	37.6	20.0
80	8.0	2.1	4.9	35.7	2.05	28.7	101.0	5.10	29.0	21.2	0.73	1.93	35.6	15.0
	4.0	4.6	10.6	36.6	2.08	29.5	101.9	5.15	30.4	22.0	0.72	1.84	36.7	16.5
	6.0	7.0	16.2	37.5	2.11	30.3	102.7	5.20	30.1	21.8	0.72	1.78	36.2	16.9
90	8.0	2.0	4.6	38.7	2.12	31.5	103.8	5.35	27.0	20.4	0.75	2.12	34.3	12.8
	4.0	4.5	10.4	39.3	2.15	32.0	104.4	5.37	27.5	20.6	0.75	2.02	34.4	13.6
	6.0	6.9	16.0	39.9	2.17	32.5	105.0	5.38	28.0	20.8	0.74	1.96	34.7	14.3
100	8.0	1.9	4.4	Operation not recommended					Operation not recommended					
	4.0	4.4	10.2						25.3	19.6	0.77	2.20	32.8	11.5
	6.0	6.8	15.7						25.7	19.8	0.77	2.13	32.9	12.1
110	8.0	1.8	4.2	Operation not recommended					Operation not recommended					
	4.0	4.3	9.9						22.9	18.4	0.80	2.36	30.9	9.7
	6.0	6.7	15.5						23.3	18.7	0.80	2.29	31.2	10.2
120	8.0	1.7	3.9	Operation not recommended					Operation not recommended					
	4.0	4.2	9.7						20.0	16.8	0.84	2.53	28.7	7.9
	6.0	6.6	15.2						20.5	17.1	0.84	2.46	28.9	8.3

5/1/11

## ZB036 - Performance Data

### Single Speed with Variable Speed ECM or 5-Speed ECM (1150 cfm)

EWT °F	Flow GPM	WPD		HEATING - EAT 70°F					COOLING - EAT 80/67°F					
		psi	ft	HC MBtu/h	Power kW	HE MBtu/h	LAT °F	COP	TC MBtu/h	SC MBtu/h	S/T Ratio	Power kW	HR MBtu/h	EER
20	5.0	2.1	4.9	Operation not recommended					Operation not recommended					
	7.0	3.7	8.5											
	9.0	5.3	12.2	22.3	1.95	15.6	86.0	3.35						
30	5.0	2.0	4.6	Operation not recommended					Operation not recommended					
	7.0	3.6	8.3	27.3	2.12	20.1	90.0	3.77	41.8	26.6	0.64	1.42	46.6	29.5
	9.0	5.2	12.0	25.6	2.07	18.5	88.6	3.62	42.4	27.1	0.64	1.33	46.9	31.8
40	5.0	2.0	4.6	Operation not recommended					Operation not recommended					
	7.0	3.6	8.3	30.5	2.23	22.9	92.6	4.01	42.2	27.6	0.65	1.60	47.6	26.4
	9.0	5.2	12.0	30.4	2.23	22.8	92.5	4.00	42.7	27.9	0.65	1.51	47.8	28.3
50	5.0	1.9	4.4	32.7	2.30	24.9	94.3	4.17	42.2	28.4	0.67	1.87	48.6	22.6
	7.0	3.5	8.1	34.0	2.35	26.0	95.4	4.25	42.6	28.5	0.67	1.78	48.7	23.9
	9.0	5.1	11.7	35.2	2.39	27.1	96.4	4.32	43.0	28.6	0.66	1.69	48.8	25.5
60	5.0	1.8	4.2	36.9	2.43	28.6	97.7	4.45	40.4	27.9	0.69	2.08	47.5	19.4
	7.0	3.4	7.9	38.1	2.47	29.7	98.7	4.53	40.9	28.0	0.68	1.99	47.7	20.6
	9.0	5.0	11.6	39.4	2.51	30.9	99.7	4.61	41.4	28.1	0.68	1.90	47.9	21.8
70	5.0	1.7	3.9	41.1	2.56	32.3	101.1	4.70	38.6	27.3	0.71	2.29	46.4	16.8
	7.0	3.3	7.6	42.3	2.59	33.5	102.1	4.79	39.2	27.5	0.70	2.20	46.7	17.8
	9.0	4.8	11.1	43.6	2.62	34.6	103.1	4.87	39.9	27.6	0.69	2.11	47.1	18.9
80	5.0	1.6	3.7	44.3	2.66	35.2	103.7	4.88	36.0	26.1	0.72	2.53	44.6	14.2
	7.0	3.2	7.3	45.3	2.69	36.1	104.5	4.93	36.6	26.3	0.72	2.42	44.8	15.1
	9.0	4.7	10.9	46.3	2.73	37.0	105.3	4.98	37.3	26.5	0.71	2.34	45.2	15.9
90	5.0	1.5	3.5	47.5	2.76	38.1	106.3	5.05	33.4	24.8	0.74	2.78	42.9	12.0
	7.0	3.1	7.2	48.2	2.80	38.7	106.8	5.06	34.0	25.1	0.74	2.66	43.0	12.8
	9.0	4.6	10.6	49.0	2.83	39.3	107.4	5.07	34.7	25.4	0.73	2.57	43.4	13.5
100	5.0	1.5	3.5	Operation not recommended					Operation not recommended					
	7.0	3.1	7.2						31.5	24.3	0.77	2.87	41.3	11.0
	9.0	4.6	10.6						32.0	24.5	0.76	2.78	41.5	11.5
110	5.0	1.4	3.2	Operation not recommended					Operation not recommended					
	7.0	2.9	6.7						28.7	23.2	0.81	3.06	39.2	9.4
	9.0	4.4	10.0						29.3	23.5	0.80	2.98	39.5	9.8
120	5.0	1.3	3.0	Operation not recommended					Operation not recommended					
	7.0	2.8	6.5						26.0	22.1	0.85	3.29	37.3	7.9
	9.0	4.3	9.9						26.6	22.4	0.84	3.20	37.5	8.3

5/1/11

## ZB041 - Performance Data

### Single Speed with Variable Speed ECM or 5-Speed ECM (1300 cfm)

EWT °F	Flow GPM	WPD		HEATING - EAT 70°F					COOLING - EAT 80/67°F					
		psi	ft	HC MBtu/h	Power kW	HE MBtu/h	LAT °F	COP	TC MBtu/h	SC MBtu/h	S/T Ratio	Power kW	HR MBtu/h	EER
20	5.0	1.6	3.8	Operation not recommended					Operation not recommended					
	8.0	3.6	8.2											
	11.0	8.0	18.5	25.2	2.40	17.0	85.9	3.08						
30	5.0	1.5	3.4	Operation not recommended					Operation not recommended					
	8.0	3.4	7.8	30.9	2.58	22.0	90.0	3.50	45.1	31.7	0.70	1.81	51.3	24.9
	11.0	7.9	18.1	29.7	2.54	21.0	89.2	3.43	45.7	32.3	0.71	1.70	51.5	26.9
40	5.0	1.3	3.0	Operation not recommended					Operation not recommended					
	8.0	3.2	7.5	34.8	2.71	25.5	92.8	3.76	47.2	32.9	0.70	1.98	54.0	23.8
	11.0	7.7	17.8	35.3	2.73	26.0	93.1	3.79	47.8	33.3	0.70	1.86	54.1	25.8
50	5.0	1.2	2.7	37.5	2.80	27.9	94.7	3.93	48.7	33.8	0.69	2.30	56.5	21.2
	8.0	3.1	7.1	39.2	2.86	29.4	95.9	4.02	49.3	34.1	0.69	2.16	56.7	22.9
	11.0	7.5	17.4	40.8	2.91	30.9	97.1	4.11	49.9	34.3	0.69	2.01	56.8	24.8
60	5.0	1.0	2.3	42.7	2.96	32.6	98.4	4.24	46.1	32.8	0.71	2.53	54.7	18.2
	8.0	2.9	6.7	44.5	3.01	34.2	99.7	4.33	46.8	33.1	0.71	2.39	55.0	19.6
	11.0	7.4	17.0	46.3	3.06	35.8	100.9	4.43	47.6	33.4	0.70	2.26	55.3	21.1
70	5.0	0.9	2.0	47.9	3.11	37.3	102.1	4.51	43.4	31.7	0.73	2.75	52.8	15.8
	8.0	2.8	6.4	49.8	3.16	39.0	103.5	4.62	44.4	32.1	0.72	2.63	53.3	16.9
	11.0	7.2	16.7	51.7	3.21	40.7	104.8	4.72	45.3	32.4	0.72	2.50	53.8	18.1
80	5.0	0.7	1.6	53.5	3.23	42.5	106.1	4.85	40.9	30.8	0.75	2.97	51.0	13.8
	8.0	2.6	6.0	54.9	3.28	43.7	107.1	4.91	41.7	31.0	0.74	2.84	51.4	14.7
	11.0	7.1	16.3	56.3	3.33	45.0	108.1	4.96	42.6	31.3	0.74	2.75	51.9	15.5
90	5.0	0.5	1.2	59.1	3.35	47.6	110.1	5.16	38.4	29.8	0.78	3.24	49.5	11.9
	8.0	2.5	5.7	60.0	3.40	48.4	110.7	5.17	39.0	29.9	0.77	3.09	49.5	12.6
	11.0	6.9	16.0	60.9	3.44	49.2	111.4	5.19	39.8	30.2	0.76	2.99	50.0	13.3
100	5.0	0.4	0.9	Operation not recommended					Operation not recommended					
	8.0	2.3	5.3						36.2	28.7	0.79	3.34	47.6	10.8
	11.0	6.8	15.6						36.8	29.0	0.79	3.23	47.8	11.4
110	5.0	0.4	0.9	Operation not recommended					Operation not recommended					
	8.0	2.1	4.9						33.0	27.3	0.83	3.57	45.2	9.3
	11.0	6.6	15.2						33.7	27.7	0.82	3.47	45.5	9.7
120	5.0	0.4	0.9	Operation not recommended					Operation not recommended					
	8.0	2.0	4.6						29.8	26.2	0.88	3.82	42.8	7.8
	11.0	6.5	14.9						30.4	26.6	0.88	3.71	43.1	8.2

10/15/15

## ZB042 - Performance Data

### Single Speed with Variable Speed ECM or 5-Speed ECM (1400 cfm)

EWT °F	Flow GPM	WPD		HEATING - EAT 70°F					COOLING - EAT 80/67°F					
		psi	ft	HC MBtu/h	Power kW	HE MBtu/h	LAT °F	COP	TC MBtu/h	SC MBtu/h	S/T Ratio	Power kW	HR MBtu/h	EER
20	5.0	2.2	5.1	Operation not recommended					Operation not recommended					
	8.0	4.9	11.3	Operation not recommended					Operation not recommended					
	11.0	7.6	17.6	25.4	2.11	18.2	84.8	3.53	Operation not recommended					
30	5.0	2.1	4.9	Operation not recommended					Operation not recommended					
	8.0	4.8	11.1	31.3	2.33	23.4	88.7	3.94	48.8	33.4	0.68	1.55	54.1	31.4
	11.0	7.5	17.2	30.4	2.28	22.6	88.1	3.91	49.5	34.1	0.69	1.46	54.5	33.9
40	5.0	2.1	4.9	Operation not recommended					Operation not recommended					
	8.0	4.8	11.1	35.1	2.45	26.7	91.2	4.20	49.5	34.0	0.69	1.77	55.6	27.9
	11.0	7.5	17.3	35.8	2.45	27.4	91.7	4.28	50.4	34.5	0.68	1.65	56.0	30.5
50	5.0	2.0	4.6	37.3	2.52	28.7	92.7	4.34	49.2	34.0	0.69	2.14	56.5	23.0
	8.0	4.7	10.9	39.2	2.57	30.4	93.9	4.47	50.2	34.5	0.69	1.99	57.0	25.2
	11.0	7.4	17.0	41.1	2.62	32.2	95.2	4.60	51.3	35.0	0.68	1.84	57.6	27.9
60	5.0	1.9	4.4	42.3	2.65	33.3	96.0	4.68	46.3	33.1	0.71	2.37	54.4	19.6
	8.0	4.6	10.5	44.2	2.70	35.0	97.2	4.79	47.4	33.5	0.71	2.22	55.0	21.3
	11.0	7.2	16.6	46.1	2.76	36.7	98.5	4.90	48.4	33.8	0.70	2.08	55.5	23.3
70	5.0	1.8	4.2	47.3	2.78	37.8	99.3	4.99	43.5	32.2	0.74	2.59	52.3	16.8
	8.0	4.5	10.4	49.2	2.84	39.5	100.5	5.08	44.5	32.4	0.73	2.46	52.9	18.1
	11.0	7.0	16.2	51.1	2.89	41.2	101.8	5.18	45.5	32.6	0.72	2.32	53.5	19.6
80	5.0	1.7	3.9	52.8	2.89	42.9	102.9	5.35	40.9	31.1	0.76	2.78	50.3	14.7
	8.0	4.5	10.4	54.1	2.94	44.1	103.8	5.40	41.7	31.3	0.75	2.65	50.7	15.7
	11.0	6.8	15.7	55.5	2.99	45.4	104.7	5.45	42.6	31.6	0.74	2.57	51.3	16.6
90	5.0	1.6	3.7	58.2	3.00	48.0	106.5	5.68	38.2	30.1	0.79	3.04	48.6	12.6
	8.0	4.4	10.2	59.1	3.04	48.7	107.1	5.69	38.8	30.3	0.78	2.90	48.7	13.4
	11.0	6.6	15.3	60.0	3.08	49.5	107.7	5.71	39.6	30.6	0.77	2.81	49.2	14.1
100	5.0	1.5	3.5	Operation not recommended					Operation not recommended					
	8.0	4.3	9.9						36.0 29.2 0.81 3.15 46.8 11.4					
	11.0	6.2	14.3						36.6 29.4 0.80 3.05 47.0 12.0					
110	5.0	1.4	3.2	Operation not recommended					Operation not recommended					
	8.0	4.2	9.7						32.9 27.8 0.84 3.38 44.4 9.7					
	11.0	6.1	14.2						33.6 28.2 0.84 3.29 44.8 10.2					
120	5.0	1.4	3.2	Operation not recommended					Operation not recommended					
	8.0	4.2	9.7						30.2 25.8 0.86 3.61 42.5 8.4					
	11.0	6.1	14.1						30.8 26.2 0.85 3.50 42.7 8.8					

5/1/11



## ZB048 - Performance Data

### Single Speed with Variable Speed ECM or 5-Speed ECM (1600 cfm)

EWT °F	Flow GPM	WPD		HEATING - EAT 70°F					COOLING - EAT 80/67°F					
		psi	ft	HC MBtu/h	Power kW	HE MBtu/h	LAT °F	COP	TC MBtu/h	SC MBtu/h	S/T Ratio	Power kW	HR MBtu/h	EER
20	6.0	2.8	6.5	Operation not recommended					Operation not recommended					
	9.0	6.1	14.1	Operation not recommended					Operation not recommended					
	12.0	10.4	24.1	31.2	2.74	21.9	86.1	3.34	Operation not recommended					
30	6.0	2.7	6.2	Operation not recommended					Operation not recommended					
	9.0	6.0	13.9	36.6	2.88	26.8	89.2	3.72	56.2	38.3	0.68	2.16	63.5	26.1
	12.0	9.5	22.0	36.3	2.93	26.3	89.0	3.63	56.9	39.1	0.69	2.02	63.8	28.1
40	6.0	2.7	6.2	Operation not recommended					Operation not recommended					
	9.0	6.0	13.9	41.5	3.07	31.0	92.0	3.96	58.1	39.5	0.68	2.41	66.3	24.1
	12.0	9.4	21.7	42.6	3.13	31.9	92.7	3.98	58.9	40.0	0.68	2.27	66.6	26.0
50	6.0	2.6	6.0	45.0	3.20	34.1	94.1	4.12	59.2	40.4	0.68	2.82	68.8	21.0
	9.0	5.9	13.6	47.0	3.27	35.8	95.2	4.21	60.0	40.7	0.68	2.66	69.1	22.5
	12.0	9.3	21.4	48.9	3.34	37.5	96.3	4.29	60.9	41.0	0.67	2.51	69.4	24.3
60	6.0	2.5	5.8	51.3	3.42	39.7	97.7	4.40	56.1	38.9	0.69	3.09	66.6	18.2
	9.0	5.8	13.4	53.7	3.49	41.8	99.1	4.51	57.1	39.2	0.69	2.94	67.1	19.4
	12.0	9.2	21.3	56.0	3.57	43.9	100.4	4.60	58.0	39.5	0.68	2.79	67.5	20.8
70	6.0	2.4	5.5	57.6	3.63	45.2	101.4	4.65	53.0	37.4	0.70	3.35	64.5	15.8
	9.0	5.4	12.5	60.4	3.71	47.7	103.0	4.77	54.1	37.7	0.70	3.21	65.1	16.9
	12.0	8.5	19.6	63.2	3.80	50.2	104.6	4.88	55.2	38.0	0.69	3.06	65.7	18.0
80	6.0	2.3	5.3	65.0	3.85	51.8	105.6	4.95	49.4	36.1	0.73	3.62	61.8	13.6
	9.0	5.3	12.2	66.9	3.92	53.5	106.7	5.01	50.3	36.3	0.72	3.46	62.1	14.6
	12.0	8.4	19.4	68.8	3.98	55.3	107.8	5.07	51.3	36.6	0.71	3.34	62.7	15.3
90	6.0	2.2	5.1	72.3	4.06	58.4	109.8	5.21	45.8	34.8	0.76	3.93	59.2	11.7
	9.0	5.2	12.0	73.4	4.12	59.3	110.5	5.22	46.5	35.0	0.75	3.74	59.3	12.4
	12.0	8.3	19.2	74.5	4.17	60.3	111.1	5.24	47.4	35.2	0.74	3.62	59.8	13.1
100	6.0	2.1	4.9	Operation not recommended					Operation not recommended					
	9.0	5.2	12.0	Operation not recommended					42.8	33.1	0.77	4.01	56.5	10.7
	12.0	8.2	18.9	Operation not recommended					43.4	33.4	0.77	3.88	56.7	11.2
110	6.0	2.0	4.6	Operation not recommended					Operation not recommended					
	9.0	5.1	11.8	Operation not recommended					38.6	31.1	0.81	4.25	53.1	9.1
	12.0	8.1	18.8	Operation not recommended					39.4	31.6	0.80	4.14	53.5	9.5
120	6.0	1.9	4.4	Operation not recommended					Operation not recommended					
	9.0	5.0	11.6	Operation not recommended					34.7	29.4	0.85	4.51	50.1	7.7
	12.0	8.0	18.5	Operation not recommended					35.4	29.9	0.84	4.38	50.4	8.1

5/1/11

## ZB060 - Performance Data

### Single Speed with Variable Speed ECM or 5-Speed ECM (2000 cfm)

EWT °F	Flow GPM	WPD		HEATING - EAT 70°F					COOLING - EAT 80/67°F					
		psi	ft	HC MBtu/h	Power kW	HE MBtu/h	LAT °F	COP	TC MBtu/h	SC MBtu/h	S/T Ratio	Power kW	HR MBtu/h	EER
20	9.0	4.6	10.6	Operation not recommended					Operation not recommended					
	12.0	7.3	16.9	Operation not recommended					Operation not recommended					
	15.0	10.0	23.1	35.5	3.36	24.0	85.3	3.09	Operation not recommended					
30	9.0	4.5	10.4	Operation not recommended					Operation not recommended					
	12.0	6.5	15.0	41.2	3.51	29.3	88.1	3.44	64.9	42.4	0.65	2.52	73.5	25.7
	15.0	8.6	19.8	41.2	3.56	29.1	88.1	3.40	65.8	43.3	0.66	2.37	73.9	27.8
40	9.0	4.5	10.4	Operation not recommended					Operation not recommended					
	12.0	6.5	15.0	46.4	3.76	33.6	90.6	3.62	66.2	44.3	0.67	2.79	75.7	23.7
	15.0	8.6	19.9	47.5	3.83	34.4	91.1	3.64	67.0	44.7	0.67	2.66	76.0	25.2
50	9.0	4.4	10.0	50.6	3.96	37.1	92.7	3.75	66.8	46.2	0.69	3.18	77.7	21.0
	12.0	6.3	14.4	52.2	4.03	38.4	93.4	3.80	67.5	46.1	0.68	3.07	77.9	22.0
	15.0	8.1	18.8	53.7	4.09	39.7	94.2	3.85	68.1	46.1	0.68	2.95	78.2	23.1
60	9.0	4.3	9.9	56.8	4.23	42.4	95.7	3.94	63.5	45.0	0.71	3.51	75.5	18.1
	12.0	6.2	14.3	59.2	4.32	44.4	96.8	4.01	64.2	45.0	0.70	3.40	75.8	18.9
	15.0	8.0	18.5	61.5	4.42	46.4	98.0	4.08	64.9	45.1	0.70	3.29	76.1	19.7
70	9.0	4.2	9.6	63.0	4.49	47.6	98.7	4.11	60.3	43.7	0.73	3.83	73.3	15.7
	12.0	6.1	14.1	66.1	4.62	50.4	100.2	4.20	60.9	43.9	0.72	3.73	73.7	16.3
	15.0	7.9	18.2	69.3	4.74	53.1	101.8	4.29	61.6	44.1	0.72	3.63	74.0	17.0
80	9.0	4.1	9.5	70.6	4.77	54.4	102.4	4.34	56.2	41.8	0.74	4.31	70.9	13.1
	12.0	6.0	13.9	72.8	4.86	56.2	103.5	4.39	57.0	42.1	0.74	4.11	71.0	13.9
	15.0	7.8	18.0	75.0	4.96	58.1	104.6	4.44	57.9	42.3	0.73	3.98	71.4	14.6
90	9.0	4.0	9.2	78.3	5.04	61.1	106.2	4.55	52.2	39.9	0.76	4.68	68.1	11.1
	12.0	5.9	13.6	79.5	5.11	62.1	106.7	4.56	53.0	40.2	0.76	4.46	68.2	11.9
	15.0	7.7	17.8	80.7	5.17	63.1	107.3	4.58	54.1	40.5	0.75	4.32	68.8	12.5
100	9.0	3.9	9.0	Operation not recommended					Operation not recommended					
	12.0	5.8	13.4	Operation not recommended					48.8	38.5	0.79	4.84	65.3	10.1
	15.0	7.6	17.6	Operation not recommended					49.5	38.8	0.78	4.68	65.5	10.6
110	9.0	3.8	8.8	Operation not recommended					Operation not recommended					
	12.0	5.7	13.2	Operation not recommended					44.1	36.5	0.83	5.18	61.8	8.5
	15.0	7.5	17.3	Operation not recommended					45.0	37.1	0.82	5.04	62.2	8.9
120	9.0	3.7	8.5	Operation not recommended					Operation not recommended					
	12.0	5.6	12.9	Operation not recommended					39.7	34.6	0.87	5.55	58.7	7.2
	15.0	7.4	17.1	Operation not recommended					40.6	35.1	0.86	5.39	59.0	7.5

5/1/11

## ZB070 - Performance Data

### Single Speed with Variable Speed ECM or 5-Speed ECM (2200 cfm)

EWT °F	Flow GPM	WPD		HEATING - EAT 70°F					COOLING - EAT 80/67°F					
		psi	ft	HC MBtu/h	Power kW	HE MBtu/h	LAT °F	COP	TC MBtu/h	SC MBtu/h	S/T Ratio	Power kW	HR MBtu/h	EER
20	12.0	5.8	13.4	Operation not recommended					Operation not recommended					
	15.0	9.1	20.9	Operation not recommended					Operation not recommended					
	18.0	12.3	28.4	42.5	3.77	29.6	86.7	3.30	Operation not recommended					
30	12.0	5.7	13.2	Operation not recommended					Operation not recommended					
	15.0	8.9	20.4	50.2	4.36	35.3	90.1	3.37	66.2	41.5	0.63	2.79	75.8	23.7
	18.0	12.0	27.7	48.6	3.99	35.0	89.4	3.57	67.1	42.4	0.63	2.62	76.1	25.6
40	12.0	5.7	13.2	Operation not recommended					Operation not recommended					
	15.0	8.9	20.4	56.9	4.40	41.9	93.1	3.79	71.3	46.6	0.65	3.05	81.7	23.4
	18.0	12.0	27.7	57.0	4.24	42.6	93.1	3.95	71.4	46.5	0.65	2.92	81.4	24.5
50	12.0	5.6	13.0	63.3	4.42	48.2	95.9	4.20	76.8	52.6	0.68	3.40	88.4	22.6
	15.0	8.6	19.8	64.3	4.45	49.2	96.4	4.24	76.3	51.6	0.68	3.31	87.6	23.0
	18.0	11.5	26.6	65.4	4.48	50.1	96.8	4.28	75.7	50.6	0.67	3.22	86.7	23.5
60	12.0	5.5	12.7	72.1	4.26	57.6	99.8	4.96	74.2	52.2	0.70	3.78	87.1	19.6
	15.0	8.4	19.3	73.6	4.50	58.2	100.4	4.79	74.2	51.7	0.70	3.69	86.7	20.1
	18.0	11.2	25.9	75.0	4.74	58.8	101.1	4.64	74.2	51.3	0.69	3.60	86.4	20.6
70	12.0	5.4	12.5	80.9	4.10	66.9	103.7	5.79	71.5	51.8	0.72	4.15	85.7	17.2
	15.0	8.2	18.9	82.8	4.55	67.3	104.5	5.34	72.1	51.9	0.72	4.06	85.9	17.7
	18.0	11.0	25.5	84.6	4.99	67.6	105.3	4.97	72.6	51.9	0.72	3.97	86.1	18.3
80	12.0	5.3	12.2	88.9	4.69	72.9	107.2	5.56	66.5	50.3	0.76	4.74	82.6	14.0
	15.0	7.9	18.2	90.6	4.94	73.7	107.9	5.37	67.2	50.4	0.75	4.52	82.6	14.9
	18.0	10.5	24.3	92.2	5.20	74.5	108.7	5.20	68.1	50.5	0.74	4.38	83.0	15.6
90	12.0	5.2	12.0	96.9	5.27	78.9	110.7	5.38	61.4	48.7	0.79	5.18	79.1	11.9
	15.0	7.7	17.7	98.4	5.34	80.1	111.4	5.39	62.3	48.9	0.78	4.94	79.2	12.6
	18.0	10.1	23.4	99.9	5.41	81.4	112.0	5.41	63.6	49.1	0.77	4.78	79.9	13.3
100	12.0	5.1	11.8	Operation not recommended					Operation not recommended					
	15.0	7.3	16.7	Operation not recommended					57.6	46.3	0.80	5.33	75.8	10.8
	18.0	9.4	21.7	Operation not recommended					58.5	46.7	0.80	5.16	76.1	11.3
110	12.0	5.0	11.6	Operation not recommended					Operation not recommended					
	15.0	6.7	15.5	Operation not recommended					52.3	43.7	0.84	5.70	71.7	9.2
	18.0	8.4	19.5	Operation not recommended					53.3	44.4	0.83	5.54	72.2	9.6
120	12.0	4.9	11.3	Operation not recommended					Operation not recommended					
	15.0	6.6	15.2	Operation not recommended					47.5	41.8	0.88	6.10	68.3	7.8
	18.0	8.3	19.1	Operation not recommended					48.5	42.4	0.87	5.92	68.7	8.2

5/1/11

# Wiring Schematics

## Aurora Base Control 208-230/60/1 PSC

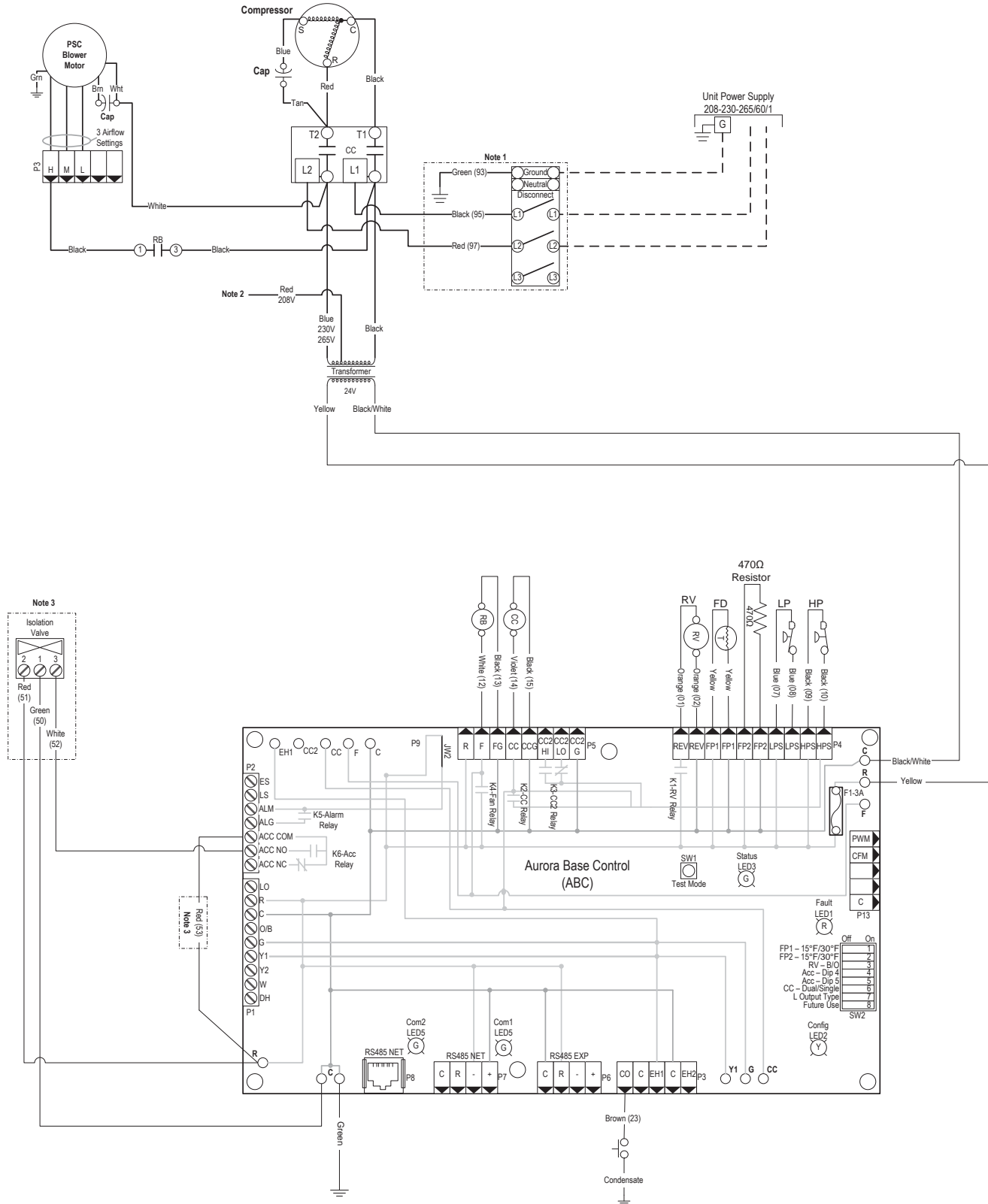

# Wiring Schematics cont.

## Aurora Base Control 208-230/60/1 PSC

### Notes:

- 1 – Optional, factory installed unit mounted disconnect.
- 2 – Swap blue and red leads for 208V operation.
- 3 – Optional, factory installed internal isolation valve.

### Legend

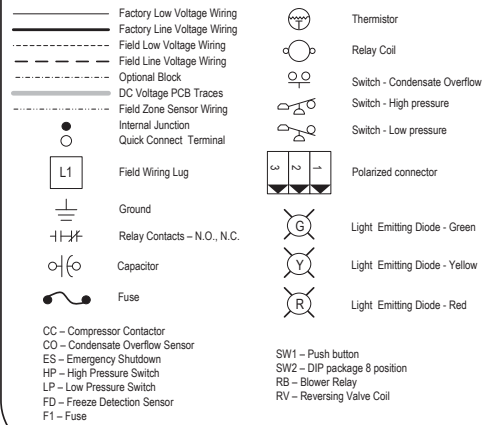

Aurora LED Flash Codes					
<b>Slow Flash</b>	1 second on and 1 second off				
<b>Fast Flash</b>	100 milliseconds on and 100 milliseconds off				
<b>Flash Code</b>	100 milliseconds on and 400 milliseconds off with a 2 second pause before repeating				
Random Start Delay					
Status LED (LED1, Green)	Fast Flash				
Configuration LED (LED2, Yellow)	Fast Flash				
Fault LED (LED3, Red)	Fast Flash				
Status LED (LED1, Green)	Configuration LED (LED2, Yellow)	Fault LED (LED3, Red)			
Normal Mode	ON	No Software Override	Flash ECM Setting	Normal Mode	OFF
Control is Non-Functional	OFF	DIP Switch Override	Slow Flash	Input Fault Lockout	Flash Code 1
Test Mode	Slow Flash	ECM Configure Mode	Fast Flash	High Pressure Lockout	Flash Code 2
Lockout Active	Fast Flash	Reset Configure Mode	Off	Low Pressure Lockout	Flash Code 3
Dehumidification Mode	Flash Code 2			Low Air Coil Limit Lockout - FP2	Flash Code 4
Reserved	Flash Code 3			Low Water Coil Limit Lockout - FP1	Flash Code 5
Reserved	Flash Code 4			Reserved	Flash Code 6
Load Shed	Flash Code 5			Condensate Overflow Lockout	Flash Code 7
ESD	Flash Code 6			Over/Under Voltage Shutdown	Flash Code 8
Reserved	Flash Code 7			Reserved	Flash Code 9
				Reserved	Flash Code 10
				Air/Water Coil Limit Sensor Error	Flash Code 11

Aurora Timing Events		
Event	Normal Mode	Test Mode
Random Start Delay	5 to 80 seconds	1 second
Compressor On Delay	5 seconds	< 1 second
Compressor Minimum On Time	2 minutes	5 seconds
Compressor Short Cycle Delay	4 minutes	15 seconds
Blower Off Delay	30 seconds	2 seconds
Fault Recognition Delay – High Pressure	Less than 1 second	Less than 1 second
Start-Up Bypass – Low Pressure	2 minutes	30 seconds
Fault Recognition Delay – Low Pressure	30 seconds	30 seconds
Start-Up Bypass – Low Water/Air Coil Limit	2 minutes	30 seconds
Fault Recognition Delay – Low Water/Air Coil Limit	30 seconds	30 seconds
Fault Recognition Delay – Condensate Overflow	30 seconds	30 seconds
Thermostat Call Recognition Time	2 seconds	2 seconds
Auxiliary Heat Staging Delay	5 minutes	20 seconds
Emergency Heat Staging Delay	2 minutes	7.5 seconds
Water Valve Slow Open Delay	90 seconds	90 seconds
Reheat Delay	30 seconds	30 seconds

Accessory Relay			
Operation	SW2-4	SW2-5	
Cycle with Blower	On	On	
Cycle with Compressor	Off	Off	
Water Valve Slow Open	On	Off	
Outdoor Air Damper	Off	On	

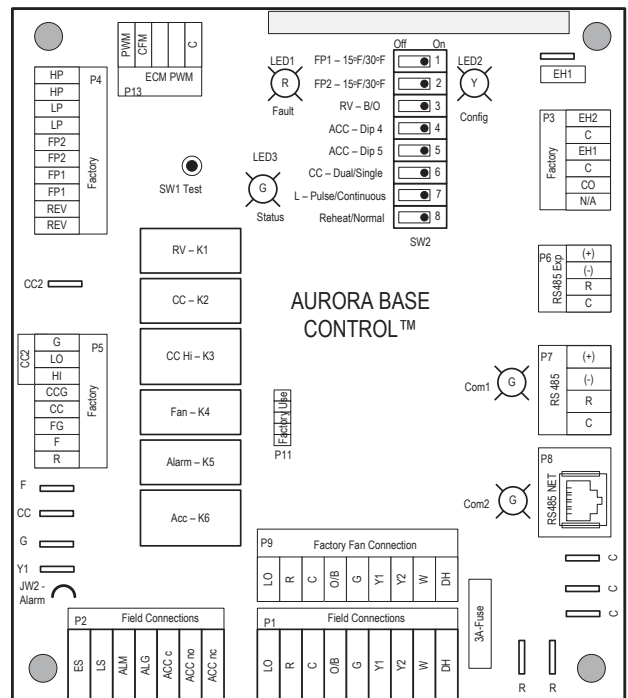

# Wiring Schematics cont.

## Aurora Base Control 460/60/3 Variable Speed ECM

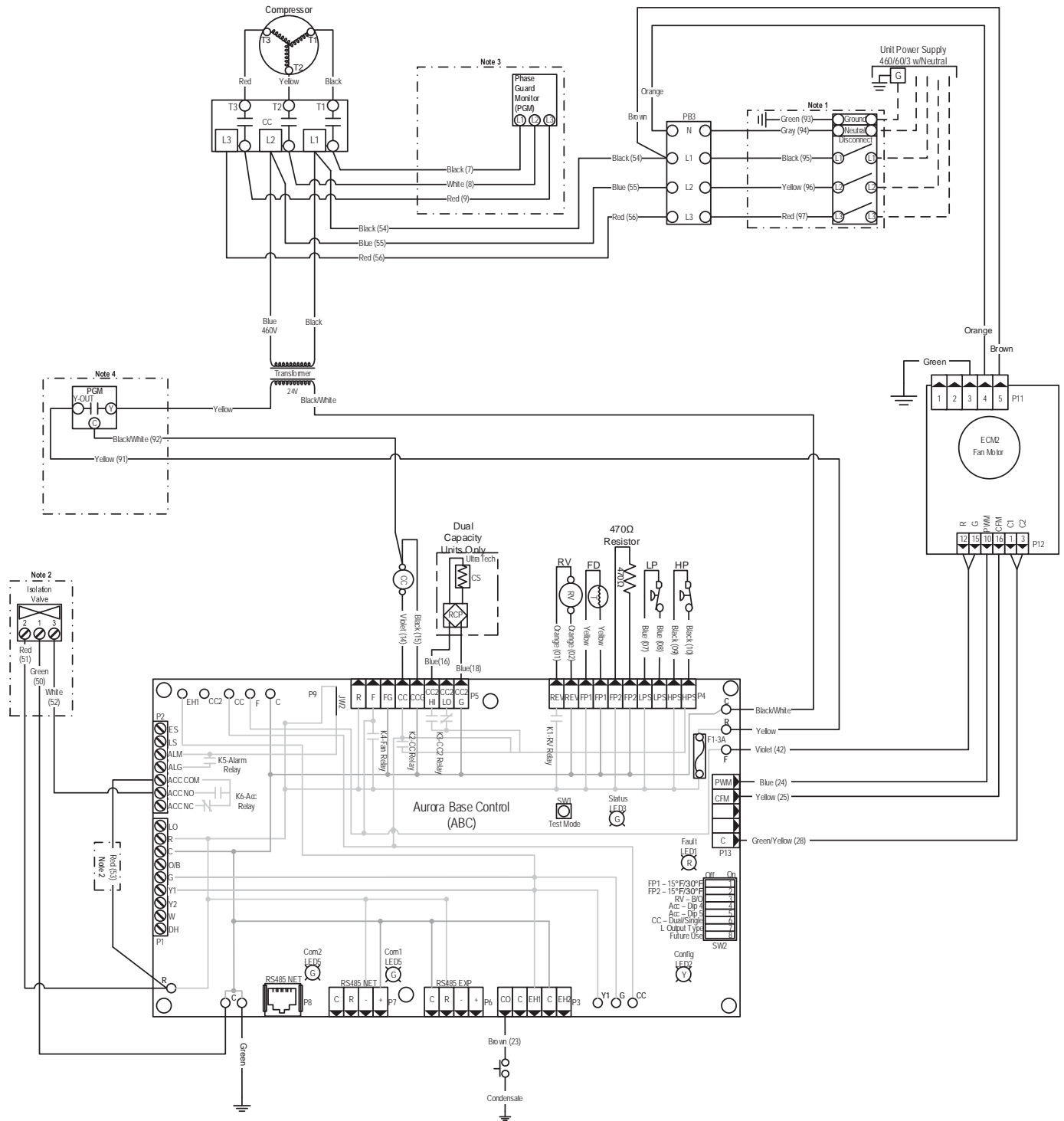

# Wiring Schematics cont.

## Aurora Base Control 460/60/3 Variable Speed ECM

**Notes:**

- 1 - Optional, factory installed unit mounted disconnect.
- 2 - Optional, factory installed internal isolation valve.
- 3 - Optional, factory installed phase guard.
- 4 - Optional, factory installed phase guard. The yellow transformer wire shall be connected directly to the CPU board, if this option is not installed.

**Legend**

Aurora LED Flash Codes					
Slow Flash	1 second on and 1 second off				
Fast Flash	100 milliseconds on and 100 milliseconds off				
Flash Code	100 milliseconds on and 400 milliseconds off with a 2 second pause before repeating				
	Random Start Delay				
Status LED (LED1, Green)	Random Start Delay	Fast Flash			
Configuration LED (LED2, Yellow)	Random Start Delay	Fast Flash			
Fault LED (LED3, Red)	Random Start Delay	Fast Flash			
	Status LED (LED1, Green)	Configuration LED (LED2, Yellow)	Fault LED (LED3, Red)		
Normal Mode	ON	No Software Override	Flash ECM Setting	Normal Mode	OFF
Control is Non-Functional	OFF	DIP Switch Override	Slow Flash	Input Fault Lockout	Flash Code 1
Test Mode	Slow Flash	ECM Configure Mode	Fast Flash	High Pressure Lockout	Flash Code 2
Lockout Active	Fast Flash	Reset Configure Mode	Off	Low Pressure Lockout	Flash Code 3
Dehumidification Mode	Flash Code 2			Low Air Coil Limit Lockout - FP2	Flash Code 4
Reserved	Flash Code 3			Low Water Coil Limit Lockout - FP1	Flash Code 5
Reserved	Flash Code 4			Reserved	Flash Code 6
Load Shed	Flash Code 5			Condensate Overflow Lockout	Flash Code 7
ESD	Flash Code 6			Over/Under Voltage Shutdown	Flash Code 8
Reserved	Flash Code 7			Reserved	Flash Code 9
				Reserved	Flash Code 10
				Air/Water Coil Limit Sensor Error	Flash Code 11

**Accessory Relay**

Operation	SW2-4	SW2-5
Cycle with Blower	On	On
Cycle with Compressor	Off	Off
Water Valves Slow Open	On	Off
Outdoor Air Damper	Off	On

**Aurora Timing Events**

Event	Normal Mode	Test Mode
Random Start Delay	5 to 80 seconds	1 second
Compressor On Delay	5 seconds	< 1 second
Compressor Minimum On Time	2 minutes	5 seconds
Compressor Short Cycle Delay	4 minutes	15 seconds
Blower Off Delay	30 seconds	2 seconds
Fault Recognition Delay - High Pressure	Less than 1 second	Less than 1 second
Start-Up Bypass - Low Pressure	2 minutes	30 seconds
Fault Recognition Delay - Low Pressure	30 seconds	30 seconds
Start-Up Bypass - Low Water/Air Coil Limit	2 minutes	30 seconds
Fault Recognition Delay - Low Water/Air Coil Limit	30 seconds	30 seconds
Fault Recognition Delay - Condensate Overflow	30 seconds	30 seconds
Thermostat Call Recognition Time	2 seconds	2 seconds
Auxiliary Heat Staging Delay	5 minutes	20 seconds
Emergency Heat Staging Delay	2 minutes	7.5 seconds
Water Valve Slow Open Delay	90 seconds	90 seconds
Reheat Delay	30 seconds	30 seconds

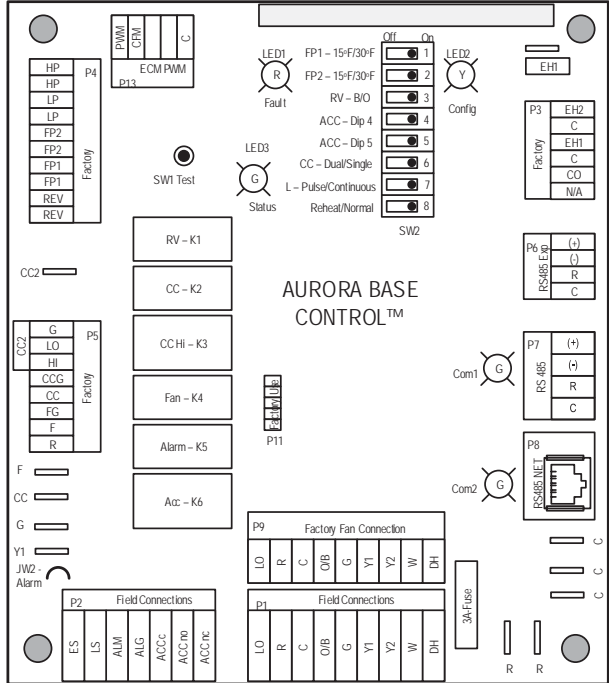

# Wiring Schematics cont.

## Aurora Base Control 460/60/3 5-Speed ECM

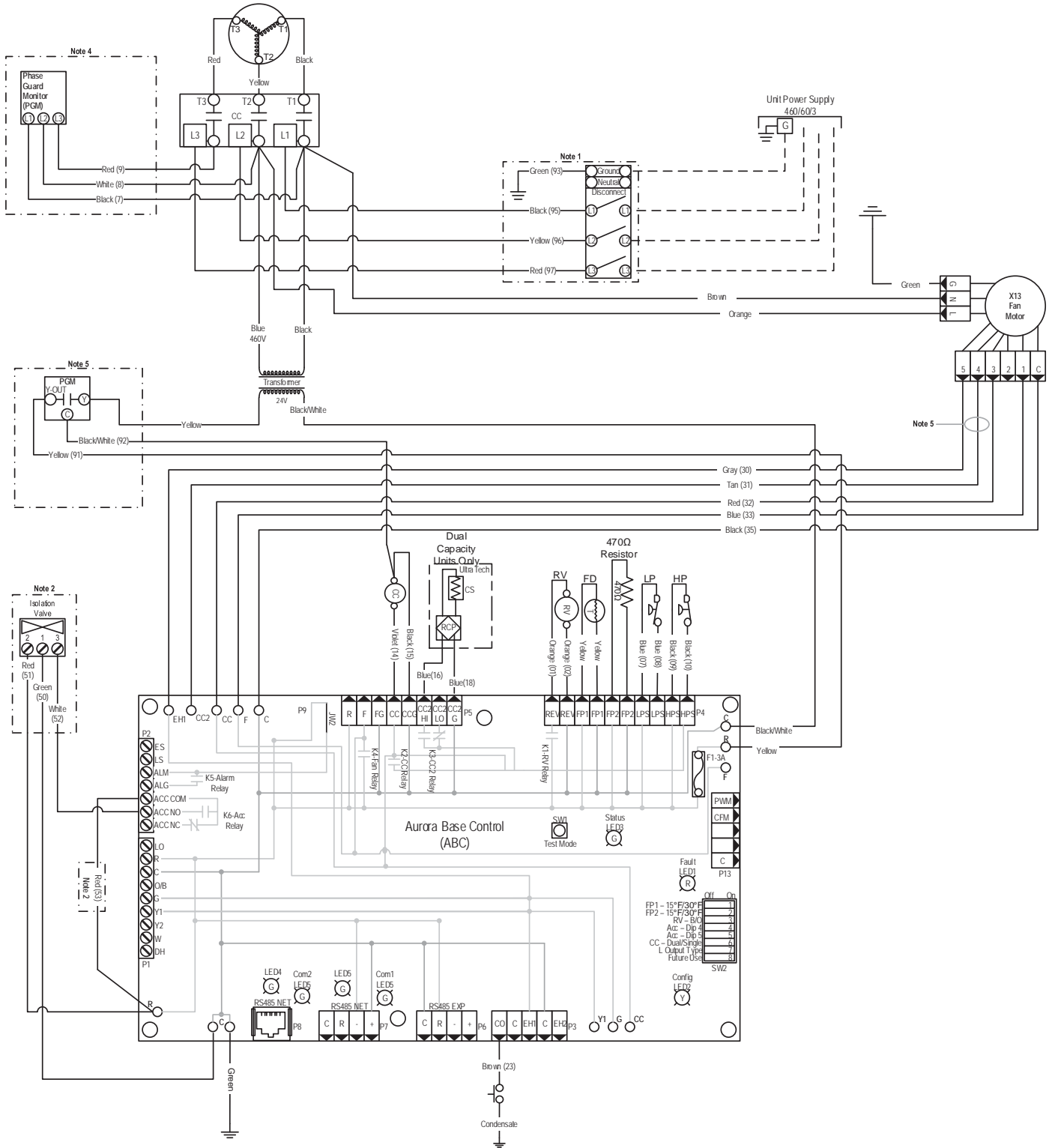



# Wiring Schematics cont.

## Aurora Base Control 460/60/3 5-Speed ECM

**Notes:**

- 1 - Optional, factory installed unit mounted disconnect.
- 2 - Optional, factory installed internal isolation valve.
- 3 - Optional, factory installed phase guard
- 4 - Optional, factory installed phase guard. The yellow transformer wire shall be connected directly to the CPU board, if this option is not installed.
- 5 - Wire is provided with the unit but only connected to the X13 motor for dual capacity units.

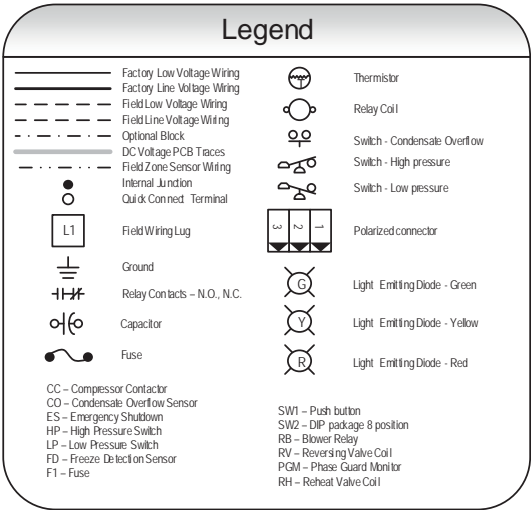

Aurora LED Flash Codes					
Slow Flash	1 second on and 1 second off				
Fast Flash	100 milliseconds on and 100 milliseconds off				
Flash Code	100 milliseconds on and 400 milliseconds off with a 2 second pause before repeating				
Random Start Delay					
Status LED (LED1, Green)	Fast Flash				
Configuration LED (LED2, Yellow)	Fast Flash				
Fault LED (LED3, Red)	Fast Flash				
Status LED (LED1, Green)		Configuration LED (LED2, Yellow)		Fault LED (LED3, Red)	
Normal Mode	ON	No Software Override	Flash EOM Setting	Normal Mode	OFF
Control Is Non-Functional	OFF	DIP Switch Override	Slow Flash	Input Fault Lockout	Flash Code 1
Test Mode	Slow Flash	ECM Configure Mode	Fast Flash	High Pressure Lockout	Flash Code 2
Lockout Active	Fast Flash	Reset Configure Mode	Off	Low Pressure Lockout	Flash Code 3
Dehumidification Mode	Flash Code 2			Low Air Coil Limit Lockout - FP2	Flash Code 4
Reserved	Flash Code 3			Low Water Coil Limit Lockout - FP1	Flash Code 5
Reserved	Flash Code 4			Reserved	Flash Code 6
Load Shed	Flash Code 5			Condensate Overflow Lockout	Flash Code 7
ESD	Flash Code 6			Over/Under Voltage Shutdown	Flash Code 8
Reserved	Flash Code 7			Reserved	Flash Code 9
				Reserved	Flash Code 10
				Air/Water Coil Limit Sensor Error	Flash Code 11

Operation	SW2-4	SW2-5
Cycle with Blower	On	On
Cycle with Compressor	Off	Off
Water Valve Slow Open	On	Off
Outdoor Air Damper	Off	On

Event	Normal Mode	Test Mode
Random Start Delay	5 to 80 seconds	1 second
Compressor On Delay	5 seconds	< 1 second
Compressor Minimum On Time	2 minutes	5 seconds
Compressor Short Cycle Delay	4 minutes	15 seconds
Blower Off Delay	30 seconds	2 seconds
Fault Recognition Delay - High Pressure	Less than 1 second	Less than 1 second
Start-Up Bypass - Low Pressure	2 minutes	30 seconds
Fault Recognition Delay - Low Pressure	30 seconds	30 seconds
Start-Up Bypass - Low Water/Air Coil Limit	2 minutes	30 seconds
Fault Recognition Delay - Low Water/Air Coil Limit	30 seconds	30 seconds
Fault Recognition Delay - Condensate Overflow	30 seconds	30 seconds
Thermostat Call Recognition Time	2 seconds	2 seconds
Auxiliary Heat Staging Delay	5 minutes	20 seconds
Emergency Heat Staging Delay	2 minutes	7.5 seconds
Water Valve Slow Open Delay	90 seconds	90 seconds
Reheat Delay	30 seconds	30 seconds

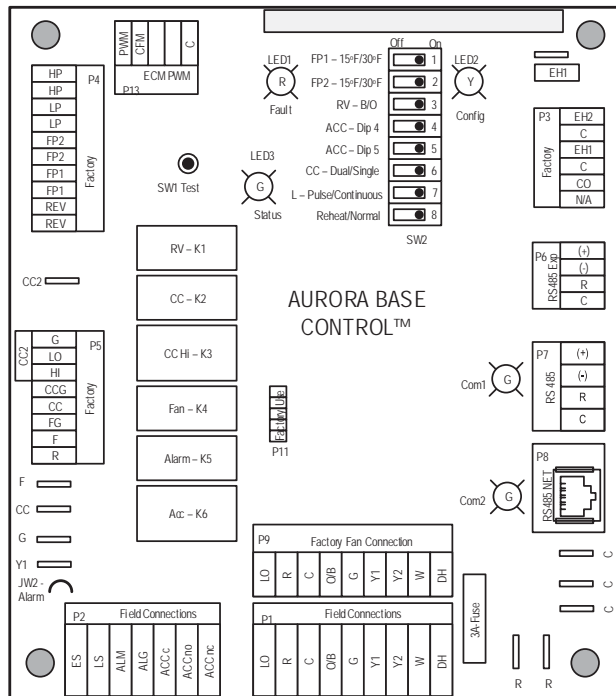

## Engineering Guide Specifications

### General

Furnish and install Water Source Heat Pumps as indicated on the plans. Equipment shall be completely assembled, piped and internally wired. Capacities and characteristics as listed in the schedule and the specifications that follow. The reverse cycle heating/cooling units shall be either suspended type with horizontal air inlet and discharge or floor mounted type with horizontal air inlet and vertical upflow air discharge. Units shall be AHRI/ISO 13256-1 certified and listed by a nationally recognized safety-testing laboratory or agency, such as ETL Testing Laboratory. Each unit shall be computer run-tested at the factory with conditioned water and operation verified to catalog data. Each unit shall be mounted on a pallet and shipped in a corrugated box or stretch-wrapped. The units shall be designed to operate with entering liquid temperature between 20°F and 120°F [-6.7°C and 48.9°C].

### Casing and Cabinet

The cabinet shall be fabricated from heavy-gauge galvanized steel. The interior shall be insulated with 1/2 in. thick, multi-density, cleanable aluminum foil coated glass fiber with edges sealed or tucked under flanges to prevent the introduction of glass fibers into the discharge air. Standard cabinet panel insulation must meet NFPA 90A requirements, air erosion and mold growth limits of UL-181, stringent fungal resistance test per ASTM-C1071 and ASTM G21, and shall meet zero level bacteria growth per ASTM G22. Unit insulation must meet these stringent requirements or unit(s) will not be accepted.

One (horizontal) to two (vertical) blower and two compressor compartment access panels shall be 'lift-out' removable with supply and return ductwork in place.

A duct collar shall be provided on the supply air opening. Standard size 1 in. [2.54 cm] MERV 4 filters shall be provided with each unit. Units shall have a return air filter rack that is field convertible from 1 in. [2.54 cm] to 2 in. [5.1 cm]. The upflow vertical units shall have a removable insulated divider panel between the air handling section and the compressor section to minimize the transmission of compressor noise and to permit operational service testing without air bypass. Vertical units shall be supplied with left or right horizontal air inlet and top vertical air discharge. Horizontal units shall be supplied with left or right air inlet and side or end air discharge.

**Option: AlpinePure MERV 13 Filter** - A 2 in. thick [51 mm] MERV 13 filter can help fulfill a credit under the LEED Rating System. Its low initial resistance promotes low energy consumption (0.21 in. w.g. @ 300 fpm) and provides nearly twice the life of a standard filter (300 fpm vs. standard 500 fpm application).  
Option: A Super Quiet Sound package shall include multi-density full coverage compressor blanket.

**Option: An internally mounted low pressure drop (high Cv) water solenoid valve** shall be factory installed for use in variable speed pumping applications.

**Option: An internally mounted automatic flow regulator** shall be set to 3 gpm/ton to deliver optimal flow to the unit.

### Refrigerant Circuit

All units shall utilize the non-ozone depleting and low global warming potential refrigerant R-410A. All units shall contain a sealed refrigerant circuit including a hermetic motor-compressor, bidirectional thermostatic expansion valve, finned tube air-to-refrigerant heat exchanger, reversing valve, coaxial tube water-to-refrigerant heat exchanger, and service ports.

Compressors shall be high-efficiency single speed rotary or rotary type designed for heat pump duty and mounted on vibration isolators. Compressor motors shall be single-phase PSC with overload protection.

The air coil shall be sized for low-face velocity and constructed of lanced aluminum fins bonded to rifled aluminum tubes in a staggered pattern not less than three rows deep for enhanced performance. The all-aluminum air coil is not susceptible to formicary corrosion.

**Option: AlumiSeal electro-coated air coil.**

The coaxial water-to-refrigerant heat exchanger shall be designed for low water pressure drop and constructed of a convoluted copper inner tube and a steel outer tube. Refrigerant to air heat exchangers shall utilize enhanced corrugated lanced aluminum fins and rifled copper tube construction rated to withstand 600 psig (4135 kPa) refrigerant working pressure. Refrigerant to water heat exchangers shall be of copper inner water tube and steel refrigerant outer tube design, rated to withstand 600 psig (4135 kPa) working refrigerant pressure and 450 psig (3101 kPa) working water pressure. The thermostatic expansion valve shall provide proper superheat over the entire liquid temperature range with minimal "hunting." The valve shall operate bidirectionally without the use of check valves.

**Option: Cupronickel refrigerant to water heat exchanger** shall be of copper-nickel inner water tube and steel refrigerant outer tube design, rated to withstand 600 psig (4135 kPa) working refrigerant pressure and 450 psig (3101 kPa) working water pressure. Water lines shall also be of cupronickel construction.

### Blower Motor and Assembly

The blower shall be a direct drive centrifugal type with a dynamically balanced wheel. The housing and wheel shall be designed for quiet low outlet velocity operation. The blower housing shall be removable from the unit without disconnecting the supply air ductwork for servicing of the blower motor. The blower motor shall be isolated from the housing by rubber grommets. The motor shall be permanently lubricated and have thermostatic overload protection.

## Engineering Guide Specifications cont.

**Option: PSC blower motor shall be a three-speed PSC type.**

**Option: 5-Speed ECM blower motor** shall be a 5-speed ECM type. The 5-speed ECM blower motor shall be soft starting, shall maintain constant torque over its operating static range, and shall provide 5 speed settings. The blower motor shall be isolated from the housing by rubber grommets. The motor shall be permanently lubricated and have thermostatic overload protection. 5-speed ECM motors shall be long-life ball bearing type.

**Option: Variable Speed ECM blower motor** shall be a variable-speed ECM type. The variable speed ECM blower motor shall be soft starting, shall maintain constant cfm over its operating static range, and shall provide 12 cfm settings. Variable speed ECM motors shall be long-life ball bearing type.

### Electrical

A control box shall be located within the unit compressor compartment and shall contain a 50VA or 75VA transformer, 24 volt activated, 2 pole compressor contactor, terminal block for thermostat wiring and solid-state controller for complete unit operation. Electromechanical operation WILL NOT be accepted. Units shall be name-plated for use with time delay fuses or HACR circuit breakers. Unit controls shall be 24 volt and provide heating or cooling as required by the remote thermostat/sensor.

An Aurora microprocessor-based controller that interfaces with a multi-stage electronic thermostat to monitor and control unit operation shall be provided. The control shall provide operational sequencing, blower speed control, high and low pressure switch monitoring, freeze detection, condensate overflow sensing, lockout mode control, LED status and fault indicators, fault memory, field selectable options and accessory output. The control shall provide fault retry three times before locking out to limit nuisance trips.

A detachable terminal block with screw terminals will be provided for field control wiring. All units shall have knockouts for entrance of low and line voltage wiring. The blower motor and control box shall be harness plug wired for easy removal.

### Piping

Supply and return water connections shall be FPT copper fittings.

With vertical units, the condensate connection shall be a 3/4 in. [19.1 mm] PVC socket with internally-trapped hose that can be routed to front or side corner post locations.

### Hanger Kit

(included with horizontal units only - field installed)

The hanger kit shall consist of galvanized steel brackets, bolts, lock washers, and isolators and shall be designed to fasten to the unit bottom panel for suspension from 3/8 in. threaded rods. Brackets shall not inhibit filter removal in any way.

### Accessories

**Thermostat** (field-installed)

A multi-stage auto-changeover electronic digital thermostat shall be provided. The thermostat shall offer two heating stages and one cooling stage with precise temperature control. An OFF-HEAT-AUTO-COOL-EMERG system switch, OFF-AUTO blower switch, and indicating LEDs shall be provided. The thermostat shall display in °F or °C.

**Hose Kits – Ball Valves** (field-installed)

A flexible steel braid hose featuring Kevlar® reinforced EPDM core with ANSI 302/304 stainless steel outer braid and fire rated materials per ASTM E 84-00 (NFPA 255, ANSI/UL 723 & UBC 8-1). Ball valve at one end; swivel connector with adapter at the other end (swivel to adapter connection via fiber or EPDM gasket). Swivel connection provides union between heat pump and piping system. The hoses feature brass fittings, stainless steel ferrules. A full port ball valve shall be provided with integral P/T (pressure/temperature) port on supply hose.

Specifications:

- Temperature range of 35°F [2°C] to 180°F [82°C].
- Max. working pressure of 400 psi [2757 kPa] for 1/2 in. and 3/4 in. hose kits; max. working pressure of 350 psi [kPa] for 1 in. and 1-1/4 in. hose kits.

## Engineering Guide Specifications cont.

---

### **Hose Kits – Automatic Balancing and Ball Valves**

(field-installed)

A flexible steel braid hose featuring Kevlar® reinforced EPDM core with ANSI 302/304 stainless steel outer braid and fire rated materials per ASTM E 84-00 (NFPA 255, ANSI/UL 723 & UBC 8-1). Ball valve at one end; swivel connector with adapter at the other end (swivel to adapter connection via fiber or EPDM gasket). Swivel connection provides union between heat pump and piping system. The hoses feature brass fittings, stainless steel ferrules. A full port ball valve shall be provided with integral P/T (pressure/temperature) port on supply hose and automatic balancing valve with integral P/T ports and full port ball valve on return hose.

Specifications:

- Temperature range of 35°F [2°C] to 180°F [82°C]
- Max. working pressure of 400 psi [2757 kPa] for 1/2 in. and 3/4 in. hose kits; max. working pressure of 350 psi [2413 kPa] for 1 in. and 1-1/4 in. hose kits
- Minimum burst pressure of four times working pressure

### **Hose Kits – Automatic Balancing and Ball Valves with ‘Y’**

**strainer** (field-installed)

A flexible steel braid hose featuring Kevlar® reinforced EPDM core with ANSI 302/304 stainless steel outer braid and fire rated materials per ASTM E 84-00 (NFPA 255, ANSI/UL 723 & UBC 8-1). Ball valve at one end; swivel connector with adapter at the other end (swivel to adapter connection via fiber or EPDM gasket). Swivel connection provides union between heat pump and piping system. The hoses feature brass fittings, stainless steel ferrules. A “y” strainer is provided on one end for fluid straining and integral “blowdown” valve. A full port ball valve shall be provided with integral P/T (pressure/temperature) port on supply hose and automatic balancing valve with integral P/T ports and full port ball valve on return hose.

Specifications:

- Temperature range of 35°F [2°C] to 180°F [82°C]
- Max. working pressure of 400 psi [2756 kPa] for 1/2 in. and 3/4 in. hose kits; max. working pressure of 350 psi [2413 kPa] for 1 in. and 1-1/4 in. hose kits
- Minimum burst pressure of four times working pressure

## Revision Guide

---

<b>Pages:</b>	<b>Description:</b>	<b>Date:</b>	<b>By:</b>
5	Update AHRI Table	28 Feb 2019	JM
All	Document Creation	10 Aug 2018	JM



Product: **Arbor Compact Series**  
Type: Geothermal/Water Source Heat Pumps  
Size: 0.5-6 Ton

Document Type: Specification Catalog  
Part Number: SC1202AZ  
Release Date: 02/19